

 **WARNING**

The symbol warns the user that, if the watch should be used in a way other than described in this instruction manual, there may be a risk of involving grave consequences including serious injury.

 **CAUTION**

The symbol alerts the user that, if the watch should be used in a way other than described in this instruction manual, a minor injury or material damage may result.

CONTENTS

1. HOW TO USE	39
(1) Display and crown/button operation	39
(2) How to use the automatic mechanical watch	40
(3) How to set the time and date	41
(4) Date adjustment at the end of the month	43
(5) How to use the chronograph	44
(6) How to use the tachymeter	49
(7) Main features of rotary slide rule	50
(8) How to use the rotating compass ring	61
2. TO PRESERVE THE QUALITY OF YOUR WATCH	64
3. LUMIBRITE	69
4. TROUBLESHOOTING	70
5. SPECIFICATIONS	72
6. REMARKS ON AFTER-SALES SERVICING	73
7. REMARKS ON REPLACEMENT PARTS	73

1. HOW TO USE

(1) Display and crown/button operation

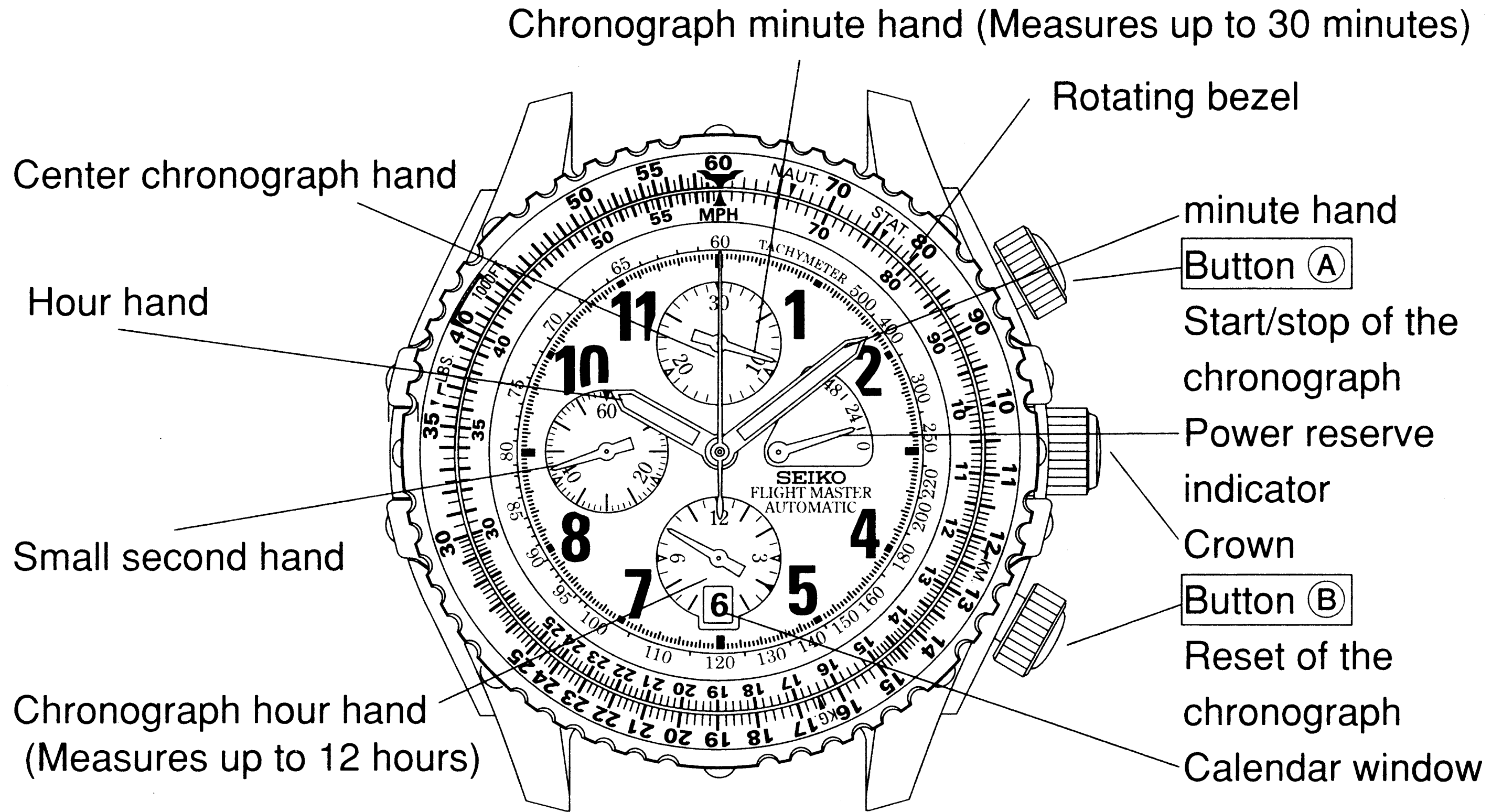

(2) How to use the automatic mechanical watch

- This is an automatic mechanical watch with manual winding mechanism.
- When the watch is worn on the wrist, the mainspring is wound automatically through normal wrist movement.
- The watch can also be wound up by turning the crown. To do so, unscrew the crown by turning it counterclockwise.
- To start the watch after it stops completely, wind it up either by turning the crown or swinging it from side to side until the second hand starts moving. Then, set the time and date before putting the watch on the wrist.
- To wind up the watch, unscrew the crown by turning it counterclockwise, and then, turn it clockwise slowly. The watch cannot be wound by turning the crown counterclockwise.
- Wind up the watch until the power reserve indicator indicates "48" on the scale. The watch is wound up fully. (Turning the crown further will not break the spring) Once the watch is wound up fully, it operates for about 50 hours.
- ✘ While the chronograph is used to measure a long period of time, however, the watch will stop operating before the power reserve indicator indicates "0".
- If the watch is used without being wound up fully, gain or loss of the watch may result. To avoid this, wear the watch for more than 8 hours a day. If the watch is used without wearing on the wrist; if it is used on the desk like a clock, for example; be sure to wind it up fully every day at a fixed time.
- ✘ Power reserve indicator function: The watch indicates the duration within which the watch keeps operating.

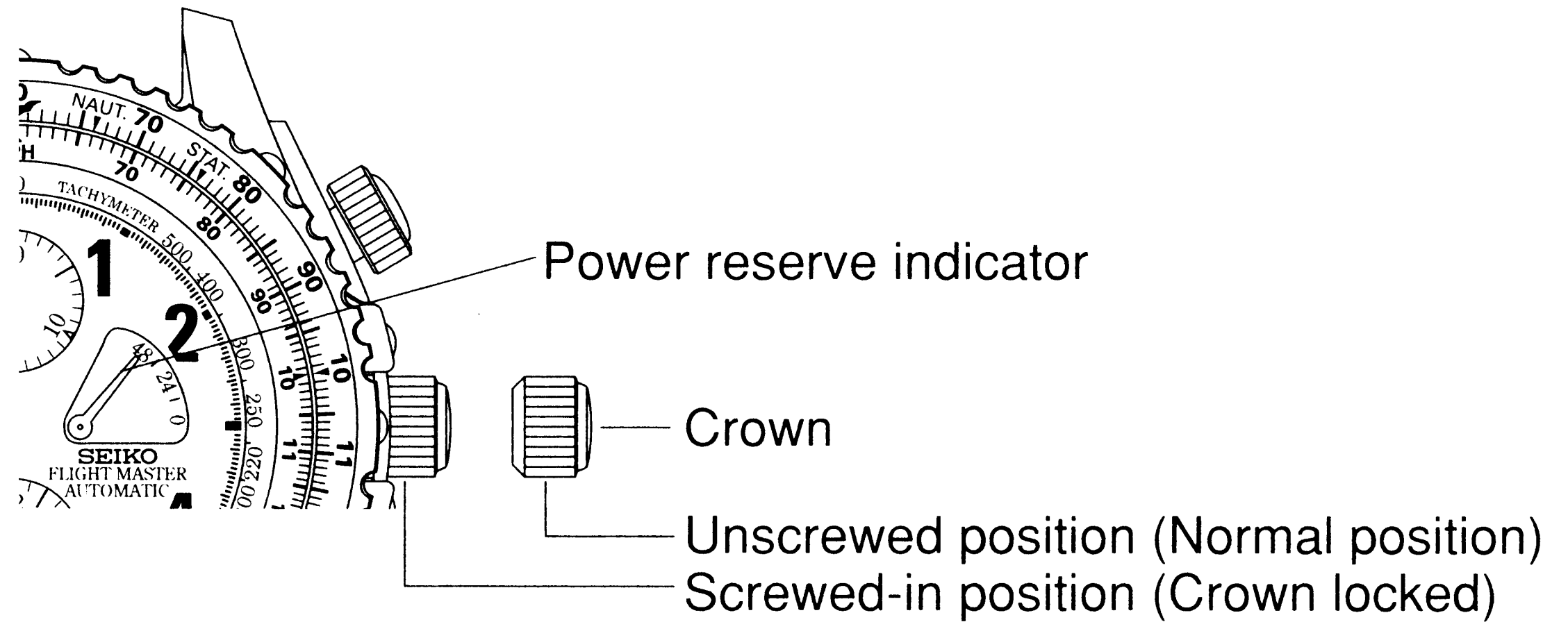

(3) How to set the time and date

- Check that the watch is operating, and then, set the time and date.
- The watch is provided with a date function and is so designed that the date changes once every 24 hours. The date changes around 12 o'clock midnight. If AM/PM is not properly set, the date will change at 12 o'clock noon.



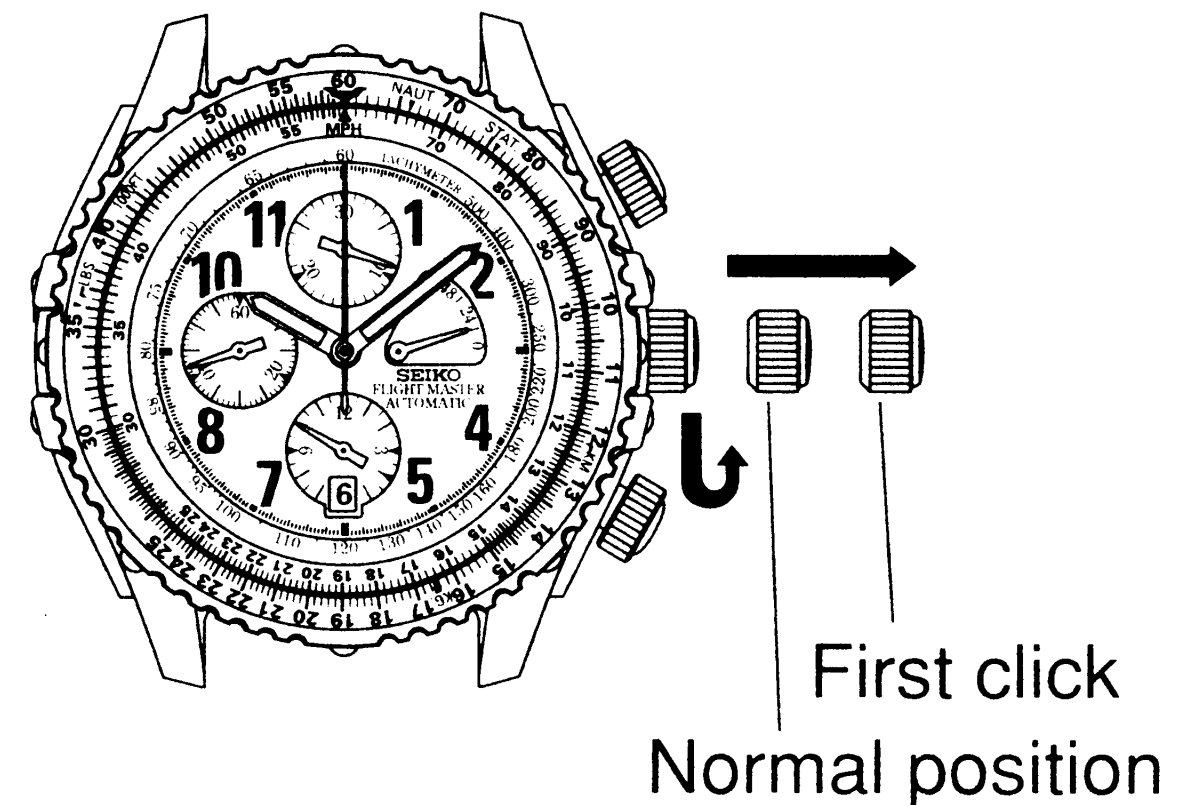

- ① Unscrew the crown by turning it counterclockwise. Pull out the crown to the first click. (The second hand continues moving.)



- ② The date can be set by turning the crown clockwise. Turn it until the previous day's date appears.

Ex.) If today is the 6th of the month, first set the date to "5" by turning the crown clockwise.



-  Clockwise:
-  Date setting
-  Counterclockwise:
-  Free

⚠ CAUTION

- Do not set the date between 8:00 p.m. and 2:00 a.m. Otherwise, the date may not change properly.

- ③ Pull out the crown to the second click when the second hand is at the 12 0'clock position. (The second hand stops on the spot.) Turn the crown to advance the hands until the date changes to the next. The time is now set for the A.M. period. Advance the hands to set the correct time.

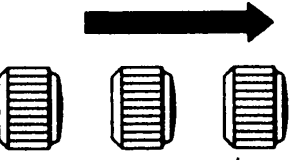

- 
- Second click

 **CAUTION**

- The mechanism of mechanical watches is different from that of quartz watches. When setting the time, be sure to turn back the minute hand a little behind the desired time and then advance it to the exact time.

④ Push the crown back in to the normal position in accordance with a time signal.

⑤ While pressing the crown, turn it clockwise until it locks in place.

※ The telephone time signal service is helpful for setting the second hand exactly.

(4) Date adjustment at the end of the month

It is necessary to adjust the date at the end of February and 30-day months.

Ex.) To adjust the date in the A.M. period on the first day of a month following a 30-day month>

(1) The watch displays "31" instead of "1". Unscrew the crown by turning it counterclockwise, and then, pull it out to the first click.

(2) Turn the crown to set the date to "1" and then push the crown back in to the normal position.

(3) While pressing the crown, turn it clockwise until it locks in place.

 **CAUTION**

- Do not set the date between 8:00 p.m. and 2:00 a.m. as this will cause a malfunction.

(5) How to use the chronograph

- The chronograph can measure up to 12 hours in 1/5 second increments.
 - ※ "Chronograph" refers to a watch function that measures the elapsed time while indicating the current time.
 - ※ Before using the chronograph, be sure to check that the center chronograph hand is at "0" position. If not, press button **(B)** to reset it to "0" position.
 - ※ Before using the chronograph, be sure to check that the watch is wound up sufficiently. If the power reserve indicator indicates less than 10 hours of power reserve, the chronograph cannot be used.

- Display and button operation

Chronograph minute hand
(Measures up to 30 minutes)

Center chronograph hand

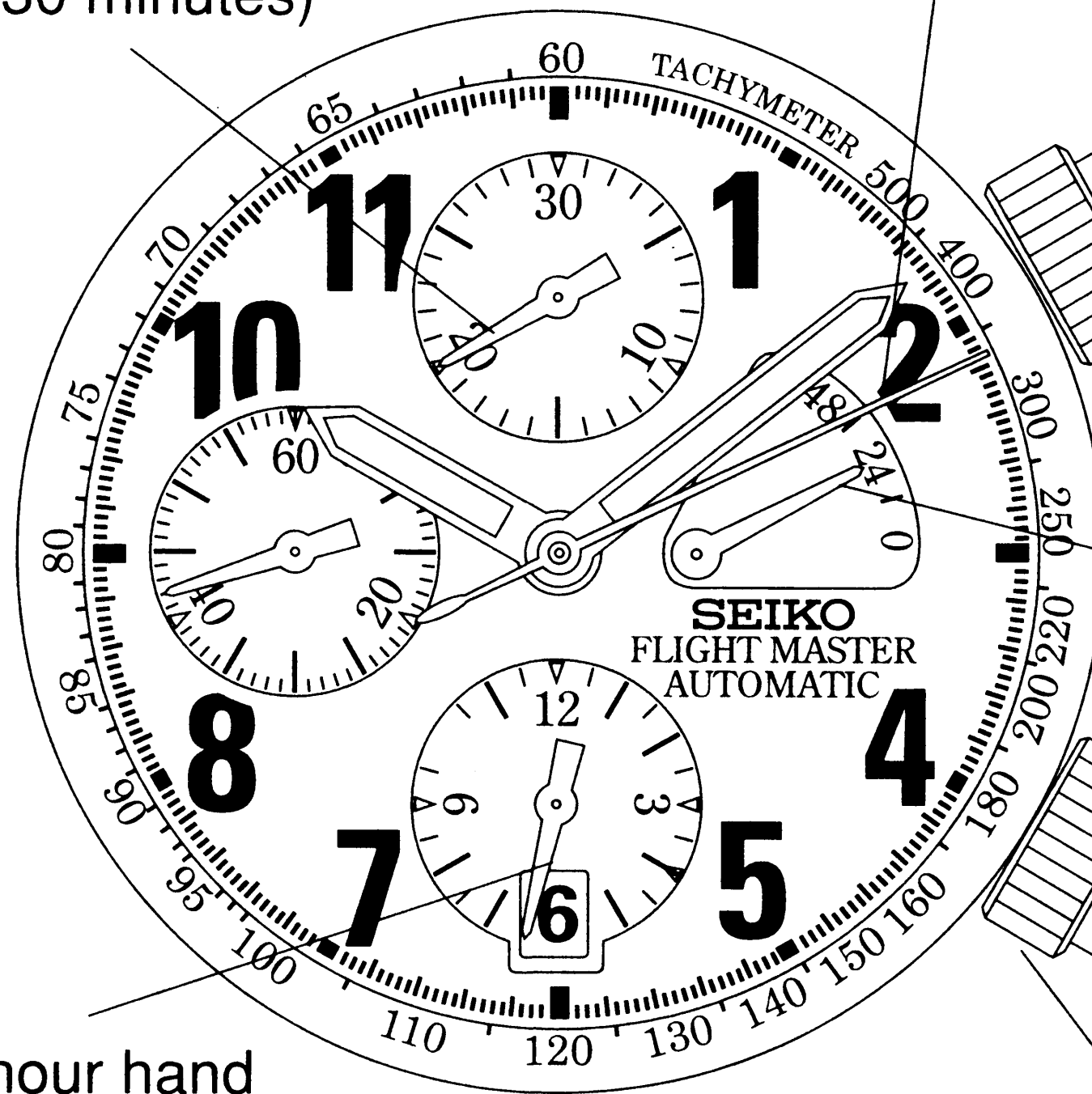

Button (A)
Start/stop of the
chronograph

Power reserve indicator

Button (B)
reset of the
chronograph

Chronograph hour hand
(Measures up to 12 hours)

(Ex.: 6 hours 20 minutes
10 seconds 06)

Button protector screwed-in
Button protector unscrewed

● To use the chronograph, unscrew the button protectors (A) and (B) by turning them clockwise to unlock the buttons. After using the chronograph, turn them counterclockwise to lock the them.

[Standard measurement] Press the buttons in the following order: (A) → (A) → (B)

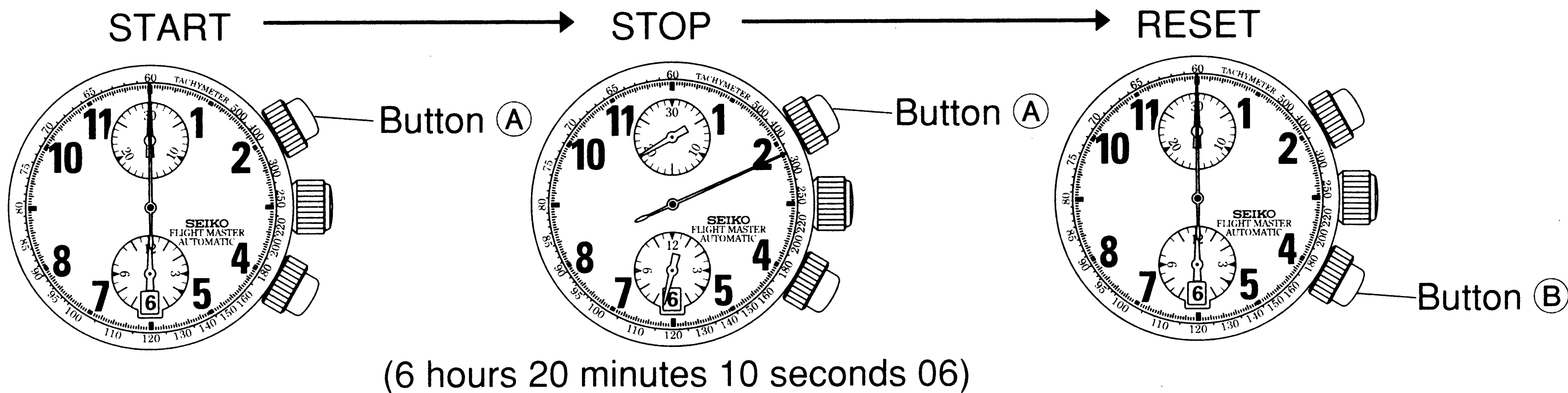

- Press button (A) to start the chronograph. The center chronograph hand will start moving.

- Press button (A) again to stop the chronograph. The chronograph hands stop to indicate the elapsed time.

- Press button (B) to reset the chronograph. All the chronograph hands will be reset to "0" position.

[Accumulated elapsed time measurement]

Press the buttons in the following order: (A) → (A) → . . . → (A) → (A) → (B)

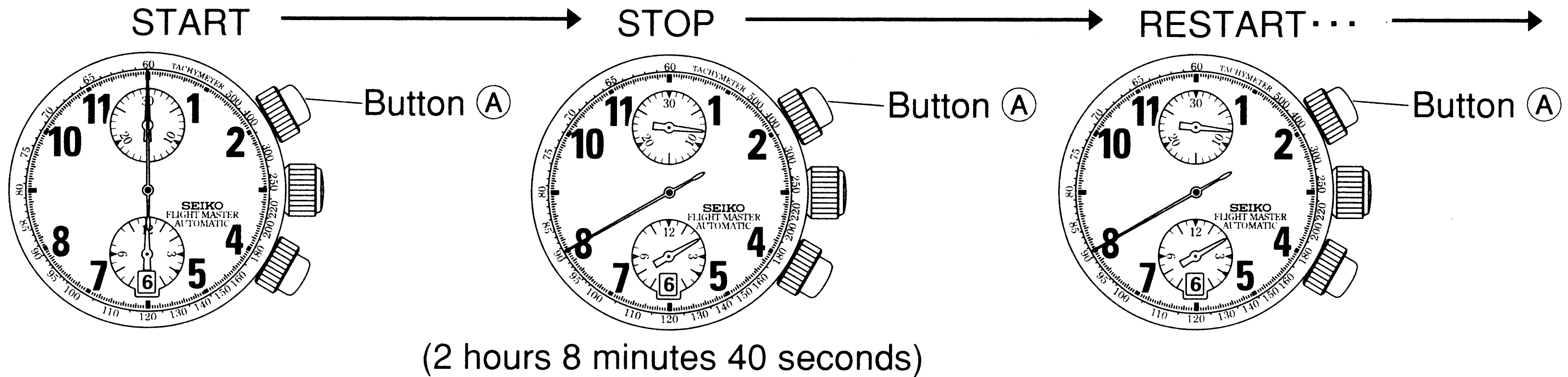

- Press button (A) to start the chronograph. The center chronograph hand will start moving.

- Restart and stop of the chronograph can be repeated during the measurement by pressing button (A). The chronograph hands will restart and stop accordingly.

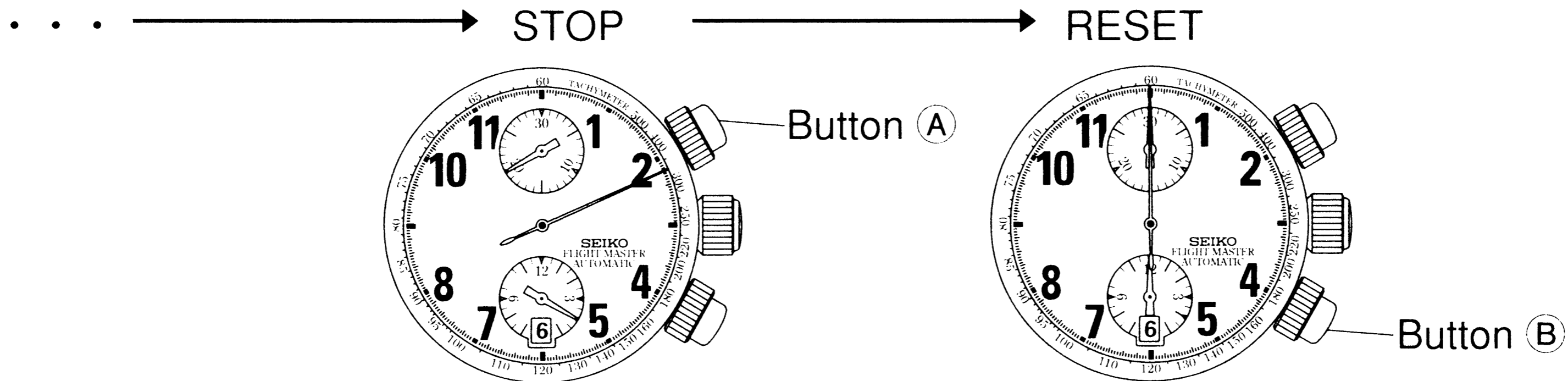

(6 hours 20 minutes 10 seconds 06)

- Press button (A) to stop the chronograph. The chronograph hands will indicate the accumulated elapsed time. Then, press button (B) to reset the chronograph. All the chronograph hands will be reset to "0" position.

(6) How to use the tachymeter (For the models with a tachymeter scale on the dial)

- The tachymeter can be used to measure the hourly average speed of a vehicle and the hourly rate of operation.

To measure the hourly average speed of a vehicle

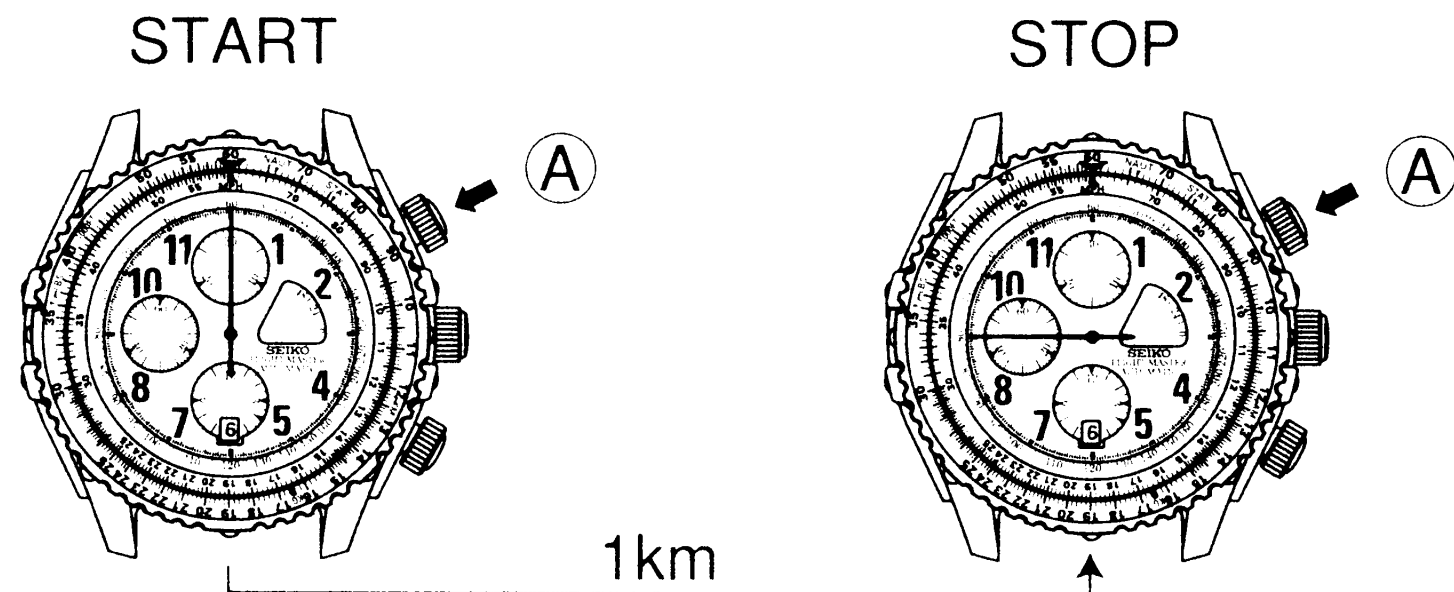

- ① Use the stopwatch to determine how many seconds it takes to go one kilometer.
- ② Read the tachymeter scale where the center chronograph hand points.

80km/h

To measure the hourly rate of operation

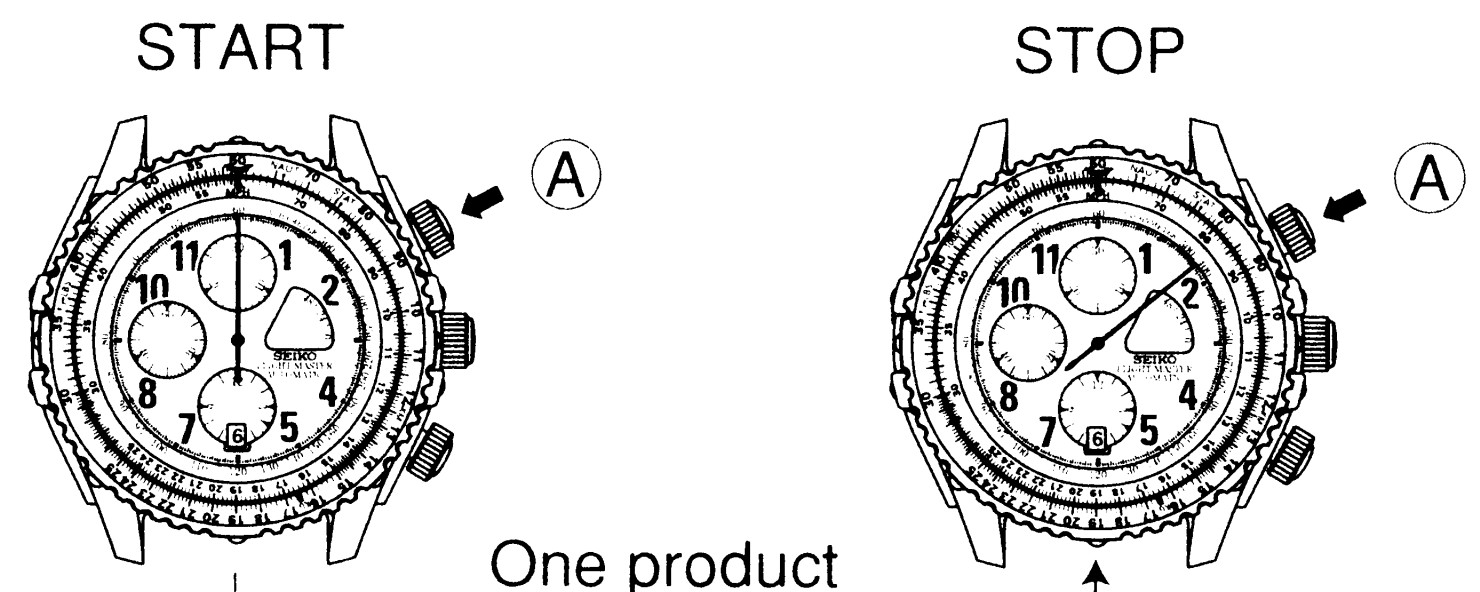

- ① Use the stopwatch to measure the time required to complete one product.
- ② Read the tachymeter where the center chronograph hand points.

400 products/hour

(7) Main features of rotary slide rule

✘ The watch is not a measuring instrument. Please note that the flight data that its rotary slide rule gives can only serve as a general guideline.

This rotating bezel type slide rule is designed for rapid calculations and conversion of various essential flight data required by pilots. With this rotary slide rule, a wide variety of computations possible, including ordinary multiplication, computation of flight speed, fuel consumption and unit conversion.

- Multiplication, division and rule - of - three calculation can be made.
- Computations for navigation including calculations of flight speed, fuel consumption rate and climbing rate can be performed.
- Conversions of various units such as distance conversion, and weight conversion can be performed.

Conversion scale

Logarithmic scale
on fixed scale

Logarithmic scale on
rotary bezel

(To read the value, apply the same rule as with the logarithmic scale on rotary bezel.)



(Any value on the logarithmic scale is relative, for example, "90" assumes any values that are the n - th power of 10, multiplied by itself ... 9, 900, 9000 ...)

■ DETERMINING THE PLACES OF FIGURES

After reading the value on the rotary bezel scale, determine the places of figures following the procedures below.

※ Please note that the following formulas do not apply to some calculation such as conversion.

Any number can be given by an exponential expression as follows.

Assume $A=a \times 10^x, B=b \times 10^y, C=10^z$, $[1 \leq a, b, c < 10]$

● Multiplication

If $A \times B = C$:

1 .Find c from the rotary bezel scale.

※ Please note that $1 \leq c < 10$. If c is more than 10, use exponential expression to find c .

2 .Calculate z following the formulas below.

$$z = x + y \quad [\text{if } c \geq a, b]$$

$$z = x + y + 1 \quad [\text{if } c < a, b]$$

3 .Calculate C .

$$C = c \times 10^z$$

● Division

If $A/B = 10$:

1 .Find c from the rotary bezel scale.

$$* 1 \leq c < 10$$

2 .Calculate z following the formulas below.

$$z = x - y \quad [\text{if } a \geq b]$$

$$z = x - y - 1 \quad [\text{if } a < b]$$

3 .Calculate C .

$$C = c \times 10^z$$

■ ORDINARY COMPUTATION

1. Multiplication, division and the rule-of-three calculation

Ⓐ Multiplication

[Problem] $30 \times 40 = ?$

[Solution]

- ① Bring 30 on the rotary bezel with 10 on the fixed scale.
- ② Read the scale on the rotary bezel corresponding to 40 on the fixed scale.
It is 12.

[Answer] 1200

Ⓑ Division

[Problem] $120 \div 40 = ?$

[Solution]

- ① Bring 12 on the rotary bezel in line with 40 on the fixed scale.
- ② Read the rotary bezel scale, corresponding to 10 on the fixed scale.
It is 30.

[Answer] 3

Ⓒ Rule-of-three calculation

[Problem] $30/10 = ? /40$

[Solution]

- ① Bring 30 on the rotary bezel in line with 10 on the fixed scale.
- ② Read the scale on the rotary bezel corresponding to 40 on the fixed scale.
The reading is 12.

[Answer] 120

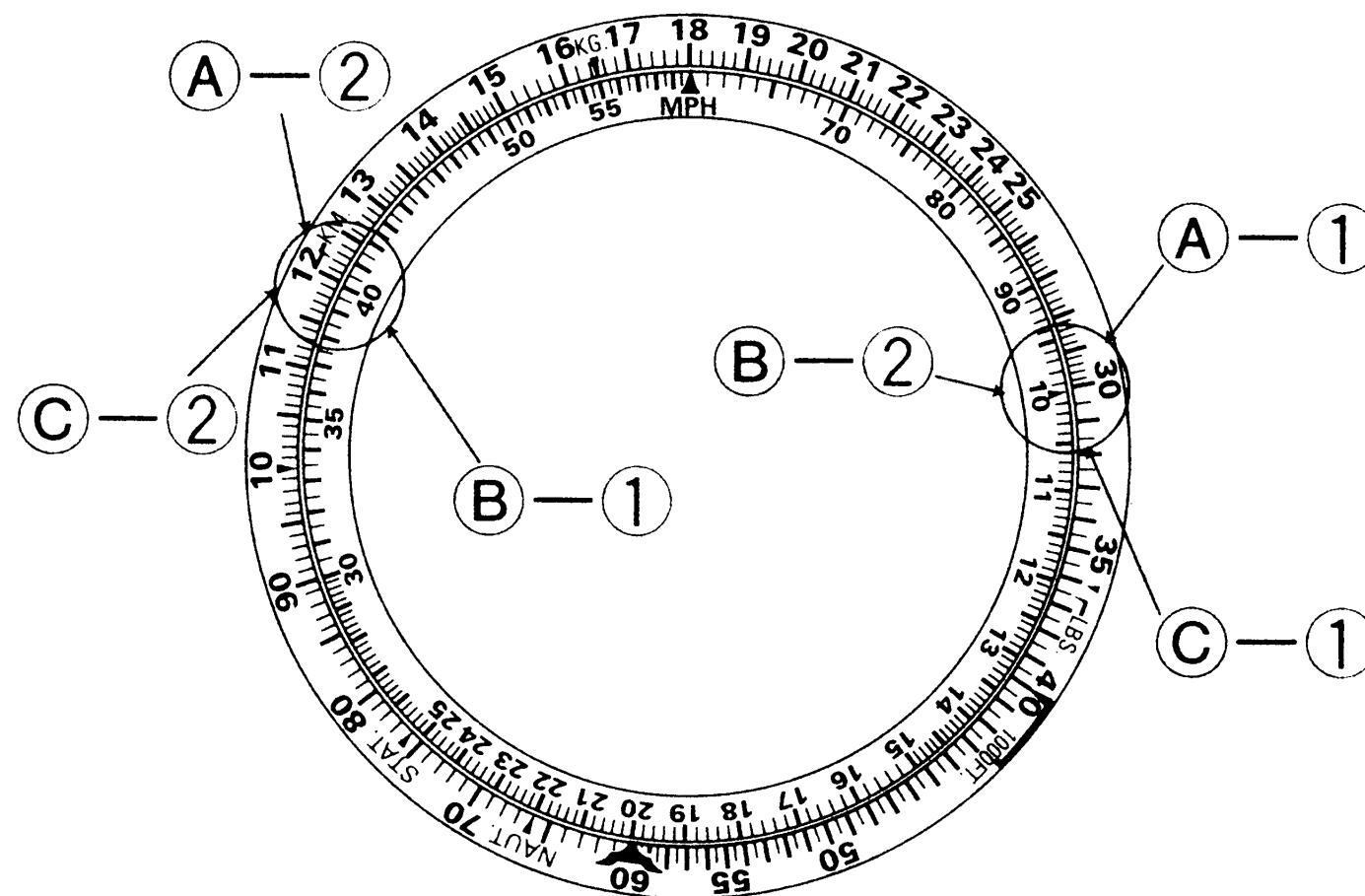

■ COMPUTATION FOR NAVIGATION

1. Calculation of time, speed and distance

Ⓐ Time calculation

[Problem]

Ground speed : 200 MPH (km/h)

Distance to fly : 100 miles (km)

Time to fly : ?

[Solution]

① Adjust 20 on the rotary bezel to MPH on the fixed scale.

② Read the fixed scale at a position corresponding to 10 on the rotary bezel. The reading is 30.

[Answer] 30 (minutes)

Ⓑ Speed calculation

[Problem]

Ground speed : ?

Distance to fly : 100 miles (km)

Time to fly : 30 minutes

[Solution]

① Adjust 10 on the rotary bezel to 30 on the fixed scale.

② The value on the rotary bezel corresponding to MPH on the fixed scale is read to be 20.

[Answer] 200 MPH (km/h)

Ⓒ Distance calculation

[Problem]

Ground speed : 200 MPH (km/h)

Distance to fly : ?

Time to fly : 30 minutes

[Solution]

① Adjust 20 on the rotary bezel to MPH on the fixed scale.

② The value on the rotary bezel that corresponds to 30 on the fixed scale is 10.

[Answer] 100 miles (km)

$$\text{SPEED} = \frac{\text{DISTANCE}}{\text{TIME}}$$

All the examples here can be calculated according to the following formula:

※ Minute is used as the time unit.

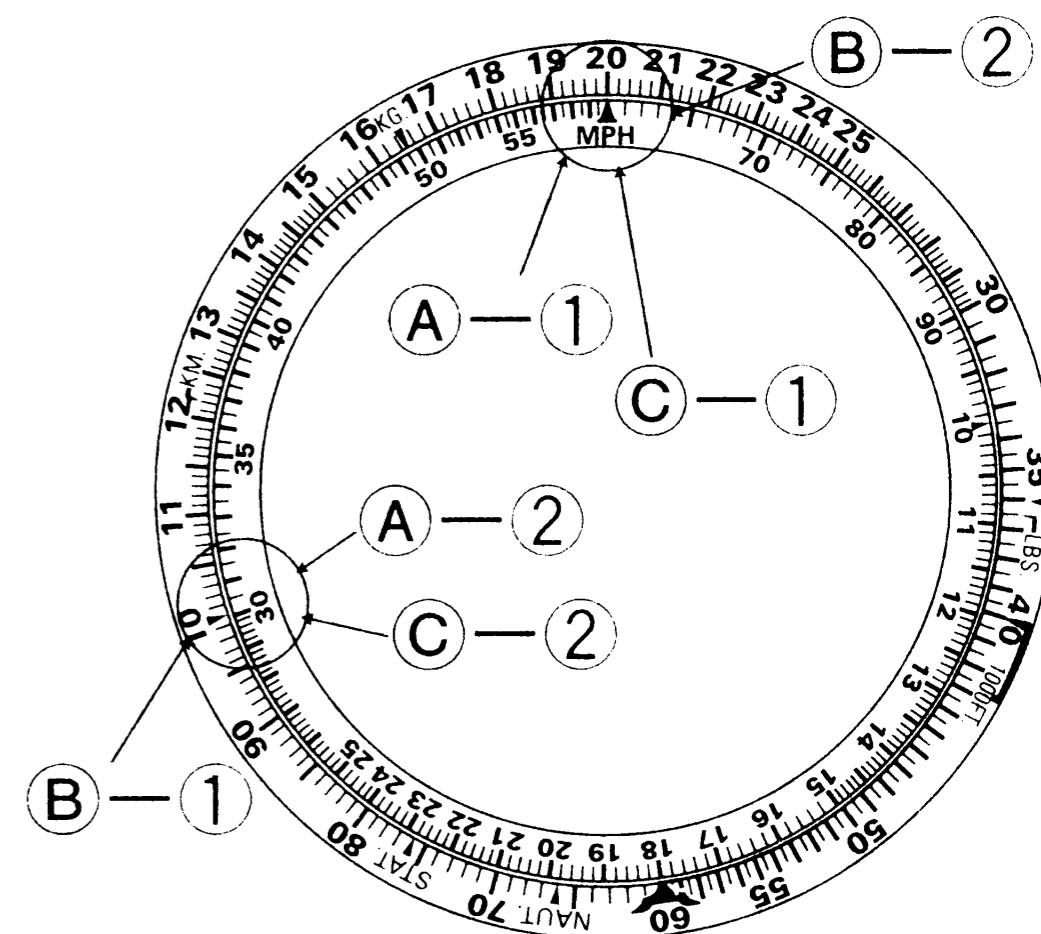

2. Calculation of fuel consumption rate, fuel quantity required, and remaining cruising time

A Calculation of fuel consumption rate

[Problem]

Time to fly : 300 minutes (5 hours)

Fuel consumption : 175 gallons (*l*)

Fuel consumption rate : ?

[Solution]

- 1 Adjust 17.5 on the rotary bezel to 30 on the fixed scale.
- 2 The rotary bezel scale value corresponding to MPH on the fixed scale is read as 35.

[Answer] 35 gallons(*l*)/hour

B Calculation of fuel quantity required

[Problem]

Time to fly : 300 minutes (5 hours)

Fuel required : ?

Fuel consumption rate :

35 gallons(*l*)/hour

[Solution]

- 1 Bring 35 on the rotary bezel in

line with MPH on the fixed scale.

- 2 Read the value on the rotary bezel which corresponds to the value 30 on the fixed scale. The reading is 17.5.

[Answer] 17.5 gallons(*l*)

C Calculation of the time remaining for cruising

[Problem]

Time available for cruising : ?

Fuel consumption : 175 gallons (*l*)

Fuel consumption rate :

35 gallons(*l*)/hour

[Solution]

- 1 Adjust 35 on the rotary bezel to MPH on the fixed scale.
- 2 Read the value on the fixed scale that corresponds to 17.5 on the rotary bezel. The reading is 30.

[Answer] 300 minutes (5 hours)

$$\text{FUEL CONSUMPTION RATE} = \frac{\text{FUEL QUANTITY REQUIRED}}{\text{TIME TO FLY}}$$

The following formula applies to all the calculations above.

✳ Minute is used as the time unit.

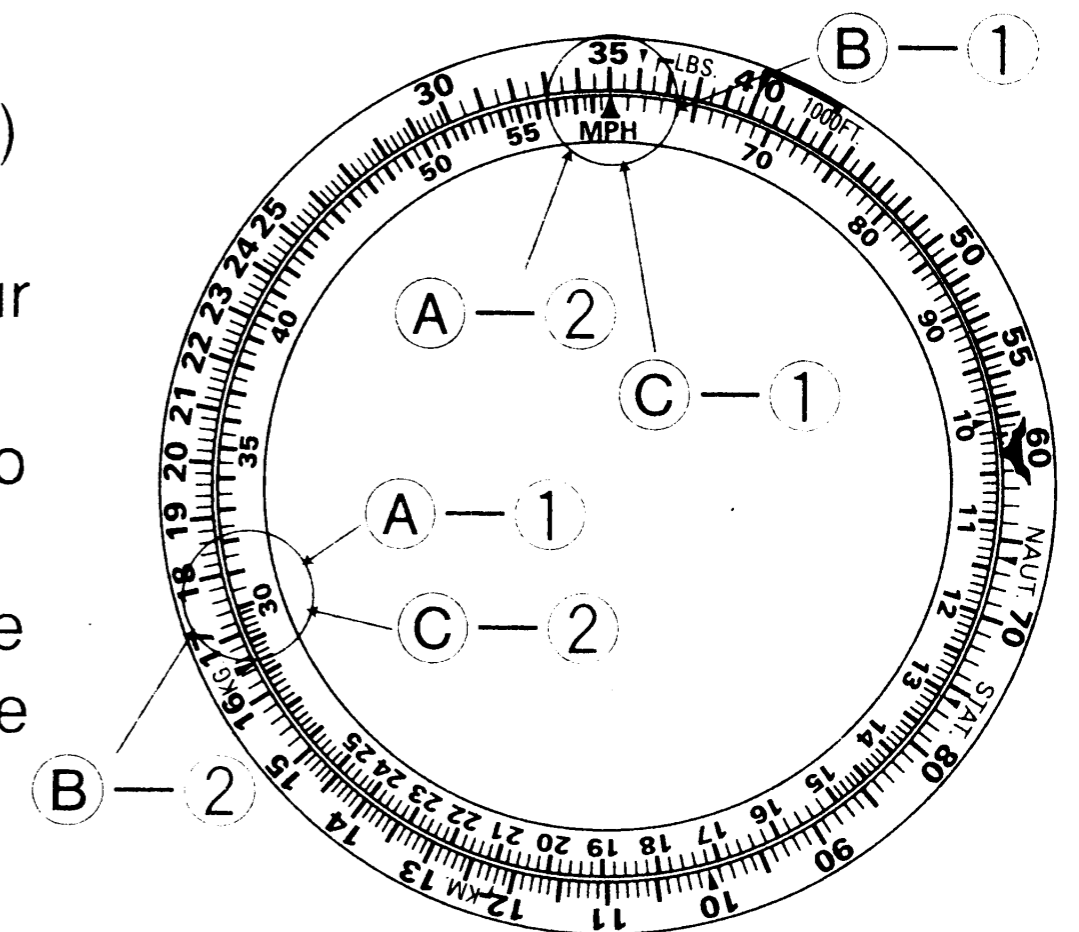

3. Calculation of climbing altitude, climbing rate, and climbing time

Ⓐ Calculation of climbing altitude

[Problem]

Climbing rate: 430 FT/minute

Climbing time: 18.6 minutes

Altitude to reach : ?

[Solution]

- 1) Adjust 43 on the rotary bezel to 10 on the fixed scale.
- 2) Find the value on the rotary bezel corresponding to 18.6 on the fixed scale. The reading is 80.

[Answer] 8000 FT

Ⓑ Calculation of climbing rate

[Problem]

Climbing rate : ?

Climbing time : 18.6 minutes

Altitude to reach : 8000 FT

[Solution]

- 1) Adjust 80 on the rotary bezel to 18.6 on the fixed scale.
- 2) Find the value on the rotary bezel

corresponding to 10 on the fixed scale. The reading is 43.

[Answer] 430 FT/minute

Ⓒ Calculation of climbing time

[Problem]

Climbing rate: 430 FT/minute

Climbing time : ?

Altitude to reach : 8000 FT

[Solution]

- 1) Adjust 43 on the rotary bezel to 10 on the fixed scale.
- 2) Find the value on the fixed scale corresponding to 80 on the rotary bezel. The reading is 18.6.

[Answer] 18.6 minutes

※ Minute is used as the time unit.

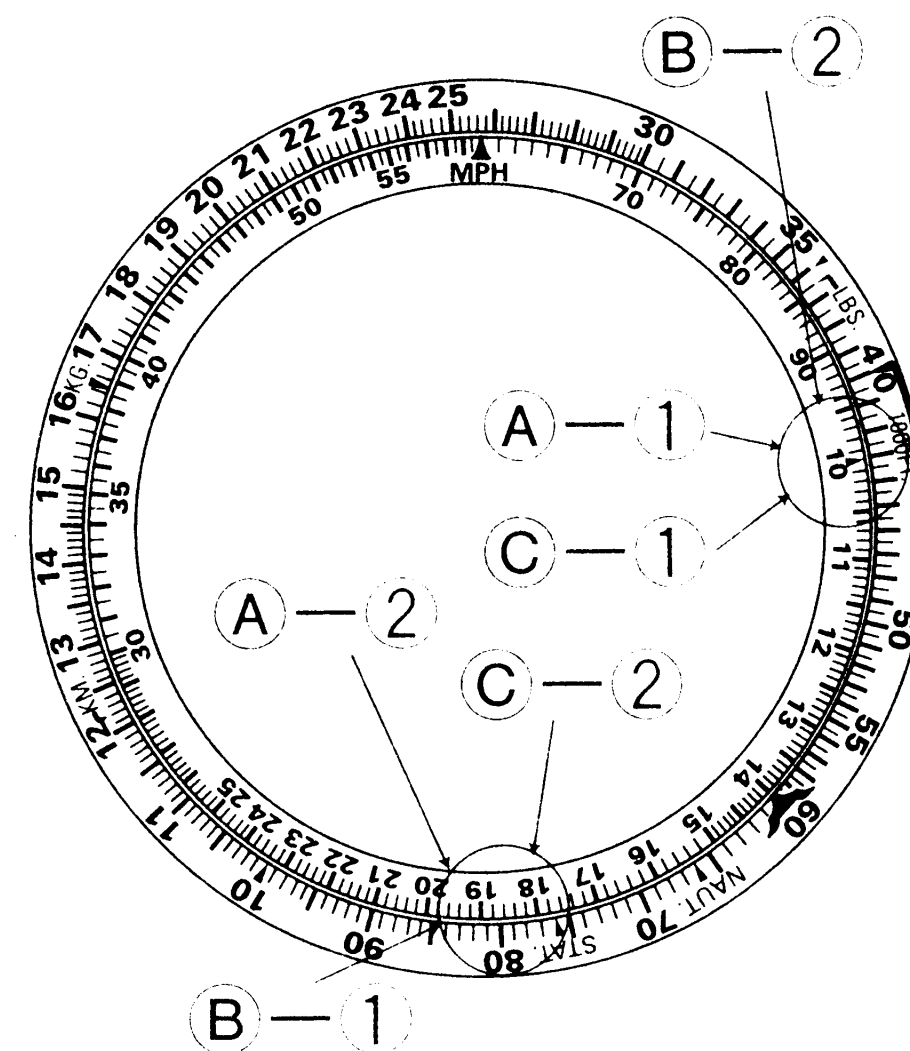

■ METHOD OF CONVERSION

For pilots, the conversion of distance, weight and various other quantities used in navigational computation from one system of units to another is important. This rotary slide rule is equipped with convenient conversion scales to facilitate this job.

Typical examples of conversions

<Distance conversion>

· Nautical miles [NAUT] \Leftrightarrow Statute miles [STAT] \Leftrightarrow kilometers [KM]

<Weight conversion>

· Pounds [LBS] \Leftrightarrow kilograms [KG]

DESCRIPTION OF MARKINGS ON THE ROTARY SLIDE RULE

Classi- fication	Marking	Explanation	Classi- fication	Marking	Explanation
Distance	NAUT.	Abbreviation of nautical mile: 1 NAUT = 1.852km	Weight	KG.	Abbreviation of kilogram: 1 KG = 2.205 pounds
	STAT.	Abbreviation of statute mile: 1 STAT = 1.609km		LBS.	Abbreviation of pounds: 1 pound = 0.45kg
	KM.	Abbreviation of kilometer: 1 KM = 3,280 feet	Speed	MPH	Abbreviation of miles per hour: 1 MPH = 1.609km/h
	FT.	Abbreviation of feet			

Note: 1 knot = 1 NAUT/h = 1.852km/h

* The watch is not a measuring instrument. The result of conversion from one system of units to another by using the rotary side rule of the watch may be different from the result of conversion by using the conversion table above.

● Conversion between nautical miles, statute miles and kilometers

A Nautical miles → Statute miles/kilometers

[Problem] 35 nautical miles

- ? statute miles
- ? kilometers

[Solution]

- 1 Bring the NAUT index on the rotary bezel in line with 35 the fixed scale.
- 2 Find the value on the fixed scale corresponding to the STAT index of the rotary bezel. The reading is about 40.3.
- 3 Find the value on the fixed scale corresponding to the KM Conversion index of the rotary bezel. The reading is about 64.8.

[Answer]

- About 40.3 statute miles
- About 64.8 kilometers

B Statute miles → Nautical miles/kilometers

[Problem]

- 40.3 statute miles
- ? nautical miles

→ ? kilometers

[Solution]

- 1 Adjust the STAT index of the rotary bezel to 40.3 on the fixed scale.
- 2 Find the value on the fixed scale that corresponds to the NAUT index of the rotary bezel. The reading is about 35.
- 3 Find the value on the fixed scale that corresponds to the KM Conversion index of the rotary bezel. The reading is about 64.8.

[Answer]

- About 35 nautical miles
- About 64.8 kilometers

C Kilometers → Statute miles/Nautical miles

[Problem] 64.8 kilometers

- ? statute miles
- ? nautical miles

[Solution]

- 1 Adjust the KM Conversion index of the rotary bezel to 64.8 on the fixed scale.
- 2 Find the value on the fixed scale that corresponds to the STAT index of the rotary bezel. The reading is about 40.3.
- 3 Find the value on the fixed scale that corresponds to the NAUT index of the rotary bezel. The reading is about 35.

[Answer]

- About 40.3 statute miles
- About 35 nautical miles

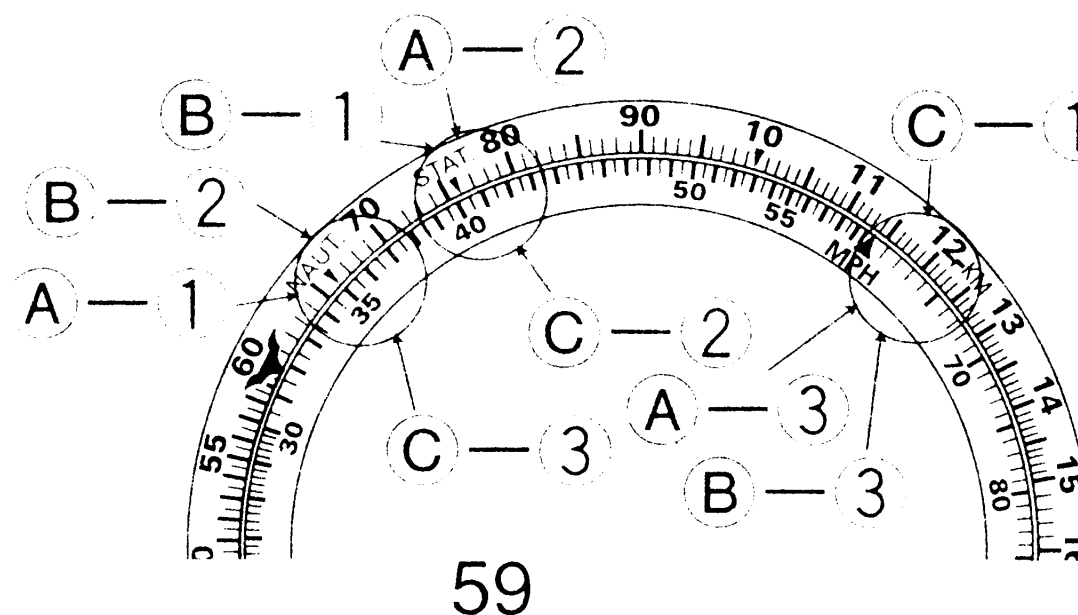

● Conversion of kilogram to pounds and pounds to kilogram

(A) Kilogram → Pounds

[Problem] 400 kilogram → ? pounds

[Solution]

- ① Adjust the KG index of the rotary bezel to 40 on the fixed scale.
- ② Find the value on the fixed scale corresponding to the LBS index of the rotary bezel. The reading is about 88.5.

[Answer]

About 885 pounds

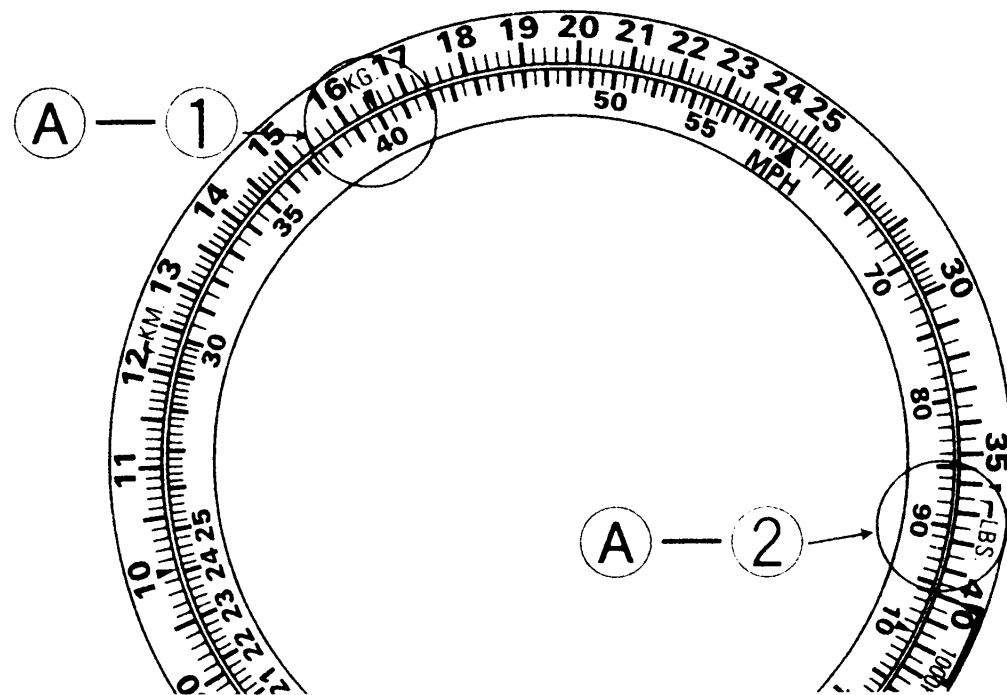

(B) Pounds → Kilogram

[Problem] 740 pounds → ? kilogram

[Solution]

- ① Adjust the LBS index of the rotary bezel to 74 on the fixed scale.
- ② Find the value on the fixed scale corresponding to the KG index of the rotary bezel. The reading is about 33.3.

[Answer]

About 333 pounds

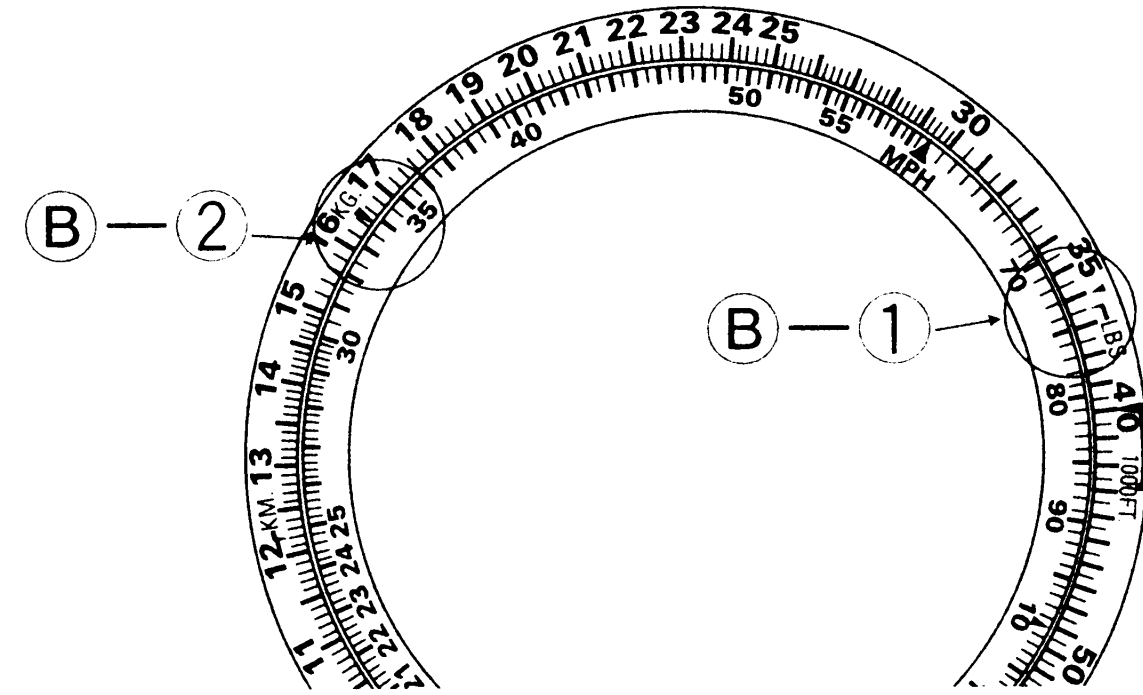

(8) How to use the rotating compass ring (For models with rotating compass ring)
[By using the ring with the hour hand (shorter hand), it can indicate the directions.]

● Precautions on using the rotating compass ring

- (1) The rotating compass ring can be used in the Northern Hemisphere only. In areas at the latitude lower than the tropic of Cancer, it may not indicate the directions properly depending on the season.
- (2) Please use the rotating compass ring in places where the direction of the sun can be checked.
- (3) Before using the rotating compass ring, it is necessary to set the hour hand to the current time of your area.
- (4) The rotating compass ring is designed to provide only the rough indications of the directions, and not the accurate directions. For such activities as mountain climbing and orienteering which require very accurate directions, be sure to use a conventional magnetic compass with this watch.

● How to use the rotating compass ring

- (1) While keeping the dial level, point the hour hand (shorter hand) to the direction of the sun.
 - (2) Set "30" (S: South) on the rotating compass ring to the middle point of the arc between the 12 o'clock marker and the time scale indicated by the hour hand. The direction marks on the ring indicate the corresponding directions. The compass ring is graduated in 15° increments. (E: East, W: West)
- ※ In the AM period, set the rotating compass ring to the middle point of the arc to the left of the 12 o'clock marker. In the PM period, set the ring to the middle point of the arc to the right of the 12 o'clock marker.

(In the AM period)

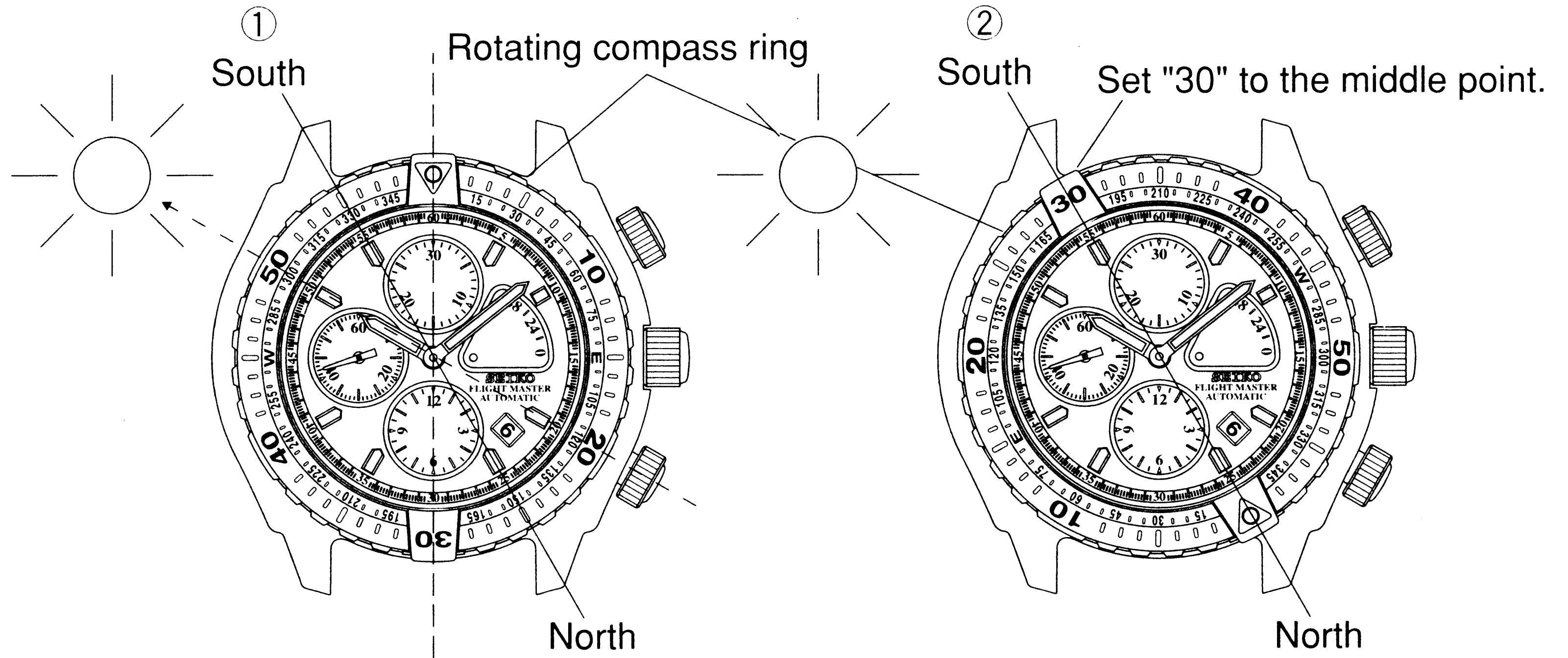

※ The design of rotating bezel or rotating compass ring differs depending on models

(In the PM period)

①

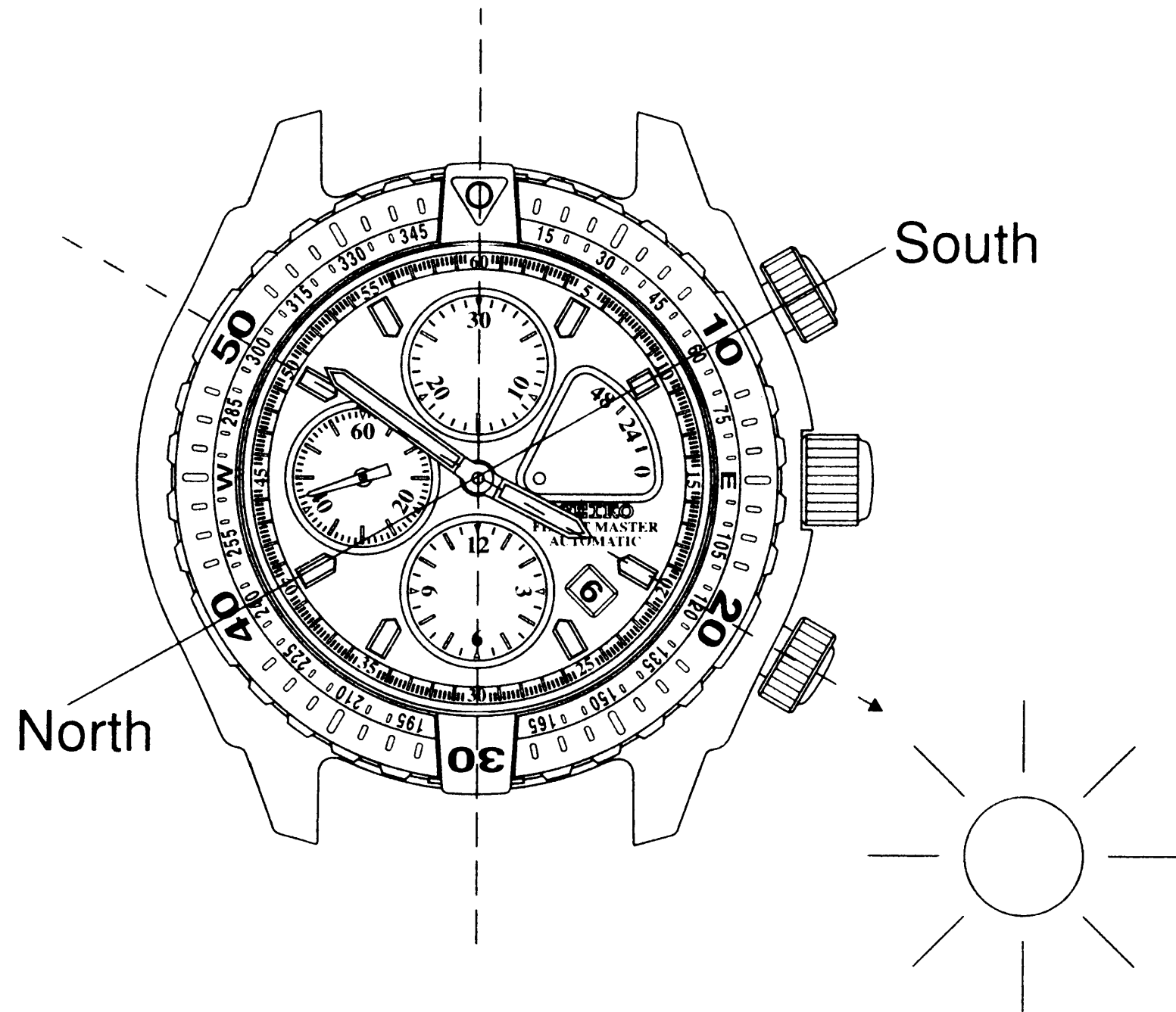

②

Set "30" to the middle point.

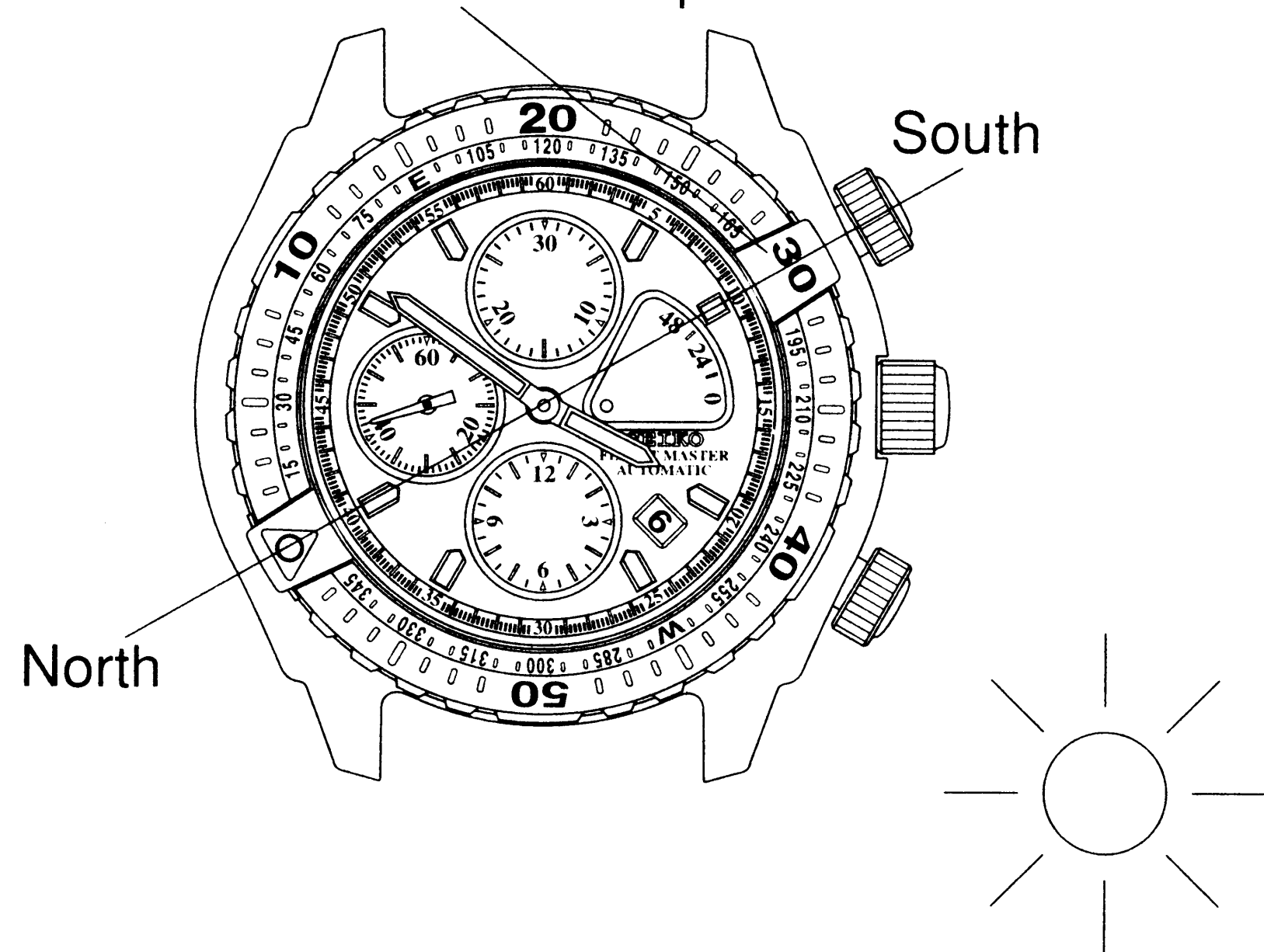

2. TO PRESERVE THE QUALITY OF YOUR WATCH

CAUTION

● CARE OF YOUR WATCH

- This watch is a silver product. Because of the nature of the material, its surface may be oxidized and lose its luster as it is used.
- When this happens, please polish the surface with a soft cloth as soon as possible. This will restore the original luster of the silver.
- The case and bracelet touch the skin directly just as underwear. If they are left dirty, the edge of a sleeve may be stained with rust of those who have a delicate skin may have a rash.
- After removing the watch from your wrist, wipe perspiration or moisture with a soft cloth. This will prevent the watch from being soiled, adding to the life of the gasket.
- If your watch is not water-resistant, be careful not to get it wet or sweat. When it gets wet, wipe it thoroughly dry with a hygroscopic cloth.







● RASH AND ALLERGY

- If you are constitutionally predisposed to rash, the band may cause you to develop a rash or an itch depending on your physical condition.
- The possible cause of the rash are as follows:
 1. Allergy to metals or leathers
 2. Rust, dust or perspiration on the watch or band
- If you develop any skin reactions, take off the watch and consult a doctor immediately.

⚠ CAUTION

● WATER RESISTANCE

- Check the dial or case back of your watch for the water resistant quality, and then see the table below.
- Do not turn or pull out the crown when the watch is wet, as water may get inside the watch.

Indication for water resistance a: Indication on the dial b: Indication on the case back		Condition of use Degree of water resistance							
			Designed and manufactured to withstand accidental contact with water such as splashes and rain.	Suitable for swimming, yachting and other aquatic sports as well as for works closely associated with water such as kitchen work, watering and fishing.	Suitable for shallow diving without a heavy breathing apparatus.	Genuine diving using scuba.	Genuine diving using helium gas.		
a	No indication	No water resistance	X	X	X	X	X	X	X
b	No indication								
a	No indication	Water resistance (3 bar)	○	X	X	X	X	X	X
b	WATER RESIST								
a	No indication	Water resistance (5 bar)	○	○	X	X	X	X	X
b	WATER RESIST or WATER RESIST 5 BAR								
a	No indication, or WATER RESIST 10 BAR	Water resistance (10 bar)	○	○	○	X	X	X	X
b	WATER RESIST 10 BAR								
a	No indication, or WATER RESIST 20 BAR	Water resistance (20 bar)	○	○	○	X	X	X	X
b	WATER RESIST 20 BAR								

 **WARNING**

- If your watch is 3 bar water resistant, do not use it in water.
- If your watch is 5 bar water resistant, do not use it in any type of diving including skin diving.
- If your watch is 10 or 20 bar water resistant, do not use it in saturation diving or scuba diving.

● PRECAUTIONS ON WEARING YOUR WATCH

- In case you tumble and fall or bump into others with the watch worn on your wrist, you may be injured by the reason of the fact that you wear the watch.
- When you make contact with children, especially with infants, they may get injured or develop a rash caused by allergy.
- Do not drop the watch or hit it against a hard surface and not wear the watch while playing active sports. The watch may gains/loses time.

 **CAUTION**

- If your watch is of the fob or pendant type, the strap or chain attached to the watch may damage your clothes, or injure the hand, neck, or other parts of your body.

● PLACES TO KEEP YOUR WATCH

- If the watch is left in a temperature below -10°C or above $+60^{\circ}\text{C}$ for a long time it may function improperly or stop operating.
- Do not leave the watch in a place where it is subjected to strong magnetism or static electricity.
- Do not leave the watch where there is strong vibration.
- Do not leave the watch in a dusty place.
- Do not expose the watch to gases or chemicals.
(Ex.: Organic solvents such as benzene and thinner, gasoline, nail polish, cosmetic spray, detergent, adhesives, mercury, and iodine antiseptic solution.)
- Do not leave the watch in a hot spring, or do not keep it in a drawer having insecticides inside.

● PERIODIC CHECK

- We suggest that you have your watch checked by SEIKO every 2 or 3 years for oil condition or damage due to water or sweat. After checking the watch, adjustment and repair may be required.
- When replacing the parts, please specify "SEIKO GENUINE PARTS."
- Be sure to have the gasket and push-pin replaced with new ones when checking the watch.

3. LUMIBRITE

[LumiBrite is a luminous paint that is completely harmless to human beings and the environment, containing no noxious materials such as radioactive substances.]

LumiBrite absorbs and stores in a short time the light energy of sunlight and electric lighting and releases it in the form of visible light for an extended period of time in the dark. For example, exposure to a fluorescent lamp of 500 luxes or higher for at least 10 minutes will enable LumiBrite to emit sufficient light for 5 to 8 hours. LumiBrite cannot generate light by itself but emits light utilizing the stored energy supplied by an external light source. Accordingly, the intensity of the light decreases gradually over time. The duration of the emitted light may also differ slightly depending on such factors as the brightness of the light to which it is exposed, the distance from the light source to the watch and the extent to which the light energy is absorbed and stored.

<Reference data on the luminance>

A. Sunlight

[Fine weather]: 100,000 lux

[Cloudy weather]: 10,000 lux

B. Indoor (Window-side during daytime)

[Fine weather]: more than 3,000 lux

[Cloudy weather]: 1,000 to 3,000 lux

[Rainy weather]: less than 1,000 lux

C. Lighting apparatus (40-watt daylight fluorescent light)

[Distance to the watch: 1m]: 1,000 lux

[Distance to the watch: 3m]: 500 lux (average room luminance)

[Distance to the watch: 4m]: 250 lux

4. TROUBLESHOOTING

Problem	Possible cause
<ul style="list-style-type: none"> The watch stops operating. 	<ul style="list-style-type: none"> The watch is not wound up sufficiently.
<ul style="list-style-type: none"> The watch stops operating before the power reserve indicator points to "0". 	<ul style="list-style-type: none"> The chronograph is in use.
<ul style="list-style-type: none"> The watch gains/loses temporarily. 	<ul style="list-style-type: none"> The watch has been left in extremely high or low temperatures for a long time.
	<ul style="list-style-type: none"> The watch was brought into close contact with a magnetic object.
	<ul style="list-style-type: none"> You dropped the watch, hit it against a hard surface or wore it while playing active sports. The watch was exposed to strong vibrations.
	<ul style="list-style-type: none"> The watch has not been overhauled for more than 3 years.
<ul style="list-style-type: none"> The date changes at 12 o'clock noon. 	<ul style="list-style-type: none"> AM/PM is not properly set.
<ul style="list-style-type: none"> The glass is blurred and the blur persists for a long time. 	<ul style="list-style-type: none"> Water got inside the watch due to the deterioration of the gasket, etc.

※For the solution of troubles other than listed above, contact the retailer from whom the watch was purchased.

Solution

- Turn the crown or swing the watch to wind it up. The watch will start operating. If the watch not, consult the retailer from whom the watch was purchased.
- Stop and reset the chronograph and turn the crown to wind up the watch. The watch will start operating. If not, consult the retailer from whom the watch was purchased.
- The normal accuracy will resume when the watch returns to normal temperature.
- The normal accuracy will resume when the watch is kept away from close contact with the magnetic source.
- If this condition persists, consult the retailer from whom the watch was purchased.
- The normal accuracy will not resume. Consult the retailer from whom the watch was purchased.
- Consult the retailer from whom the watch was purchased.
- Advance the hands by 12 hours.
- Consult the retailer from whom the watch was purchased.

5. SPECIFICATIONS

Cal.	6S37
1. Function	7 hands
	Time display (Hour, minute and small second hands)
	Chronograph function
	(Center chronograph hand, chronograph minute hand (measures up to 30 minutes) and hour chronograph hand (measure up to 12 hours))
	Power reserve indicator function (Power reserve indicator)
2. Vibrations per hour	28,800
3. Loss/gain (daily rate)	+15~ -10seconds
4. Driving system	Automatic winding type with manual winding mechanism
5. Jewels	40 jewels

※ The mechanism of mechanical watches is very precise and delicate. Time accuracy may change depending on which direction the watch faces. Therefore, any actual loss/gain may not fall within the range of time accuracy specified above, and depends on the conditions of use, such as the length of time during which the watch is worn on the wrist, temperature, life style (whether much arm movement is involved or not), whether the watch is wound up fully or not, etc.

※ The above specifications are subject to change without prior notice, for product improvement.

6. REMARKS ON AFTER-SALES SERVICING

- If the watch required service, take it to retailer from whom the watch was purchased. If the trouble occurs within the guarantee period, submit the certificate of guarantee together with the watch.
- For repair after the guarantee period or for any other information regarding the watch, contact the retailer from whom the watch was purchased or the "CUSTOMER SERVICE DEPARTMENT" of SEIKO CORPORATION or the "SEIKO SERVICE CENTER CO., LTD."
- Guarantee coverage is spelled out in the certificate of guarantee. Please read it carefully and keep the certificate for ready.

7. REMARKS ON REPLACEMENT PARTS

- SEIKO makes it policy to usually keep a stock of spare parts for its watches for 7 years. In principle, your watch can be reconditioned within this period if used normally. (Replacement parts are those which are essential to maintaining the functional integrity of the watch.)
- The number of years that a watch is considered repairable may vary greatly depending on the conditions under which it was used, and normal accuracy may not be achieved in some cases. We recommend, therefore, that you consult the retailer from whom the watch was purchased when having them repair your watch.
- The case, dial, hands, glass and bracelet, or parts there of may be repaired with substitutes if the originals are not, available.
- Repair fees may exceed the standard retail price. depending on the kind of repairs if you have any questions, please contact the CUSTOMER SERVICE DEPARTMENT OF SEIKO CORPORATION or SEIKO SERVICE CENTER CO., LTD.