

wiredwena

N857

INSTRUCTION MANUAL

Thank you very much for choosing wiredwena N857.
This product includes wena 3 provided by Sony Corporation and a watch head capable of operating and displaying the wena 3 functions.

■ **Please make sure to read the following instructions before use.**

- Startup Guide and Reference Guide for wena 3 supplied with the package
- Help Guide on the wena support page
- QUICK MANUAL of the watch head supplied with the package
- The instruction (this document) on the Customer Service page on the Seiko Watch Corporation's website

Keep this manual handy for easy reference.

- ※ The band of this product features an easy-adjust mechanism, but if adjustment of the metallic band is desired, please ask the retailer from whom the watch was purchased. If you cannot have your watch repaired by the retailer from whom the watch was purchased because you received the watch as a gift or you moved to a distant place, please contact SEIKO CUSTOMER SERVICE CENTER. The service may also be available on a chargeable basis at other retailers, however, some retailers may not undertake the service.
- ※ If your watch has a protective film for preventing scratches, make sure to peel it off before using the watch. If the watch is used with the film on it, dirt, sweat, dust, or moisture may be attached to the film and may cause rust.

CONTENTS

1. ABOUT THIS PRODUCT

Handling Precautions.....	3
About the Radio Act.....	5
About the Radio Act.....	5
About Radio frequency	5
Cautions for Use of 2.4 GHz Equipment	5
Use of Bluetooth Communication Function of the Watch outside Japan	5
About Bluetooth®	6
Specifications of Bluetooth.....	6
Caution for Use of Bluetooth Connection	6
License and Trademark	6
Contact Information.....	7
Watch head and band (not including wena 3).....	7
Clasp section (wena 3).....	7
Removing and attaching the clasp section (wena 3).....	8
How to remove the clasp section (wena 3).....	8
How to attach the clasp section (wena 3).....	8
Features	9
Names of Parts	9
Functions of This Watch	10

2. Connection of wena 3 and the watch head

Initial Settings.....	11
Remarks on pairing.....	11
Initial setting procedure	11
STEP 4: Pair wena 3 with the watch head.	12
How to Disconnect, Reconnect, and Delete Pairing	13
Turning off the connection with wena 3.....	13
Reconnecting with wena 3.....	13
When connection with wena 3 cannot be achieved.....	13

3. Function link with wena 3

Function Link	14
How to set the function link	14
Automatic time synchronization function	15
Sleep & Alarm Settings.....	15
How to use the function link	16

4. MANUAL TIME ADJUSTMENT FUNCTION

How to Adjust Time Manually	17
Operation Method.....	18

5. HAND POSITION ADJUSTMENT

How to Adjust Hand Position	19
Operation Method.....	20

6. TO PRESERVE THE QUALITY OF YOUR WATCH

Daily Care.....	21
Performance and Type	21
Water Resistance	22
Band	23
Remarks on Battery	24
After-Sales Service	25

7. TROUBLESHOOTING

Troubleshooting	26
How to Reset Built-In IC (System Reset).....	30
Operation Method.....	30

8. SPECIFICATIONS

Specifications.....	32
---------------------	----

1. ABOUT THIS PRODUCT

Handling Precautions (1)

WARNING

To indicate the risks of serious consequences such as severe injuries unless the following safety regulations are strictly observed.

- Immediately stop wearing the watch in the following cases.
 - If the watch body or band becomes edged by corrosion, etc.
 - If the pins protrude from the band
 - ※ Immediately consult the retailer from whom the watch was purchased or SEIKO CUSTOMER SERVICE CENTER.
- Keep the watch and accessories out of the reach of babies and children.

Care should be taken to prevent a baby or a child from accidentally swallowing accessories.
If a baby or a child swallows the battery or accessories, immediately consult a doctor as it will be harmful to the health of the baby or child.
- Do not remove the battery from the watch.

Replacement of the battery requires professional knowledge and skill. For battery replacement, please ask the retailer from whom the watch was purchased .
Do not charge the battery.
It may explode, generate heat or catch fire.

CAUTION

To indicate the risks of light injuries or material damage unless the following safety regulations are strictly observed.

- Avoid wearing or storing the watch in the following places.
 - Places where volatile agents (such as polish remover, bug repellent, thinners, etc.) are vaporizing
 - Places where the temperature drops below 5°C or rises above 35°C for a long time
 - Places of high humidity
 - Places affected by strong magnetism or static electricity
 - Dusty places
 - Places affected by strong vibrations
 - ※ Do not leave the old battery inside the watch for a long time. Battery leakage may occur.
- If you observe any allergic symptoms or skin irritation, Stop wearing the watch immediately and consult a specialist such as a dermatologist or an allergist.
- Other cautions
 - For models that use an easy-adjust band, please be careful not to hurt your hands or fingers with the pins, spring bars or the edge of the tool when adjusting the length of the band or removing the clasp section (wena 3).
 - Replacement of the metal band requires professional knowledge and skill. Please ask the retailer from whom the watch was purchased for replacement of the metal band, as there is a risk of hand or finger injury and fear of losing parts.
 - Do not disassemble or tamper with the watch.
 - Keep the watch out of the reach of babies and children. Extra care should be taken to avoid risks of any injury or allergic rash or itching that may be caused when they touch the watch.
 - When disposing of used batteries, follow the instructions of your local authorities.
 - If your watch is of the fob or pendant type, the strap or chain attached to the watch may damage your clothes, or injure the hand, neck, or other parts of your body.

1. ABOUT THIS PRODUCT

Handling Precautions (2)

WARNING



Do not use the watch for scuba diving or saturation diving.
The various tightened inspections under simulated harsh environment, which are usually required for watches designed for scuba diving or saturation diving, have not been conducted on this watch. For diving, use special watches for diving.



The radio waves emitted from this product may have a negative impact and cause an accident due to a malfunction.

- Do not use this product near medical equipment. The radio waves may affect pacemakers and electric medical equipment. Do not use it in crowded places such as packed trains, and inside of medical institutions.
- Do not use this product near automatic control devices such as automatic doors and fire alarm systems.



In the places where use of radio waves is restricted, such as in airplanes, turn off wena 3 to disconnect the communication between the watch head and wena 3.
The radio waves emitted from this product may adversely affect other devices.

CAUTION



Do not pour running water directly from faucet onto the watch.
The water pressure of tap water from a faucet is high enough to degrade the water resistant performance of a water resistant watch for everyday life.



Do not push the buttons when the watch is wet.
Water may get inside of the watch.
※ If the inner surface of the glass is clouded with condensation or water droplets appear inside of the watch for a long time, the water resistant performance of the watch is deteriorated. Immediately consult the retailer from whom the watch was purchased or SEIKO CUSTOMER SERVICE CENTER.



Do not leave moisture, sweat and dirt on the watch for a long time.
Be aware of a risk that a water resistant watch may lessen its water resistant performance because of deterioration of the adhesive on the glass or gasket, or the development of rust on stainless steel.



Do not wear the watch while taking a bath or a sauna.
Steam, soap or some components of a hot spring may accelerate the deterioration of water resistant performance of the watch.

1. ABOUT THIS PRODUCT

About the Radio Act

About the Radio Act

This product is certified as a low power data communication system based on the Radio Act in Japan.

It is not necessary to obtain a license, etc., to use this product in Japan.

It is illegal to disassemble and modify this product.

[Certification No.]



About Radio frequency

The frequency used by this product may be used also by other wireless equipment. To prevent radio wave interference with other radio equipment, be careful about the following when using this product.

This radio product uses the 2.4 GHz band. As a modulation method, the GFSK modulation method is adopted, and the interference distance is 10 m.

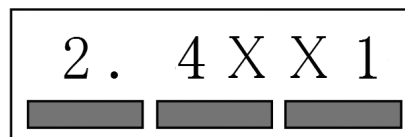

Cautions for Use of 2.4 GHz Equipment

The operation frequency of this product is 2.4 GHz band.

In this frequency band, besides industrial/scientific/medical equipment such as microwave ovens, other similar radio stations, in-plant radio stations for mobile object identification that require licenses used for manufacturing lines, etc., of plants, specific low power radio stations that do not require licenses, amateur radio stations, etc. (hereinafter referred to as "other radio stations") are operated.

- Before using this product, make sure that "other radio stations" are not operating nearby.
- If radio wave interference occurs between this product and "other radio stations", change the location in which this product is used or stop using this product (stop emitting radio waves) immediately.

- If you have any questions or troubles, please contact the SEIKO CUSTOMER SERVICE CENTER.

Use of Bluetooth Communication Function of the Watch outside Japan

This watch head uses Bluetooth wireless technology to connect to wena 3 for the function link. To use its Bluetooth function in countries or regions outside Japan, the watch must be certified by the radio law thereof. Performing communication between this watch head and wena 3 in a country or region where this is not authorized may subject the user to punishment.

Use of the Bluetooth function of the watch other than the following countries and regions may be illegal (as of January 2021).

Japan, Belgium, Bulgaria, Czech, Denmark, Germany, Estonia, Ireland, Greece, Spain, France, Croatia, Italy, Cyprus, Latvia, Lithuania, Luxembourg, Hungary, Malta, the Netherlands, Austria, Poland, Portugal, Rumania, Slovenia, Slovakia, Finland, Sweden, Turkey, Norway, Iceland, Liechtenstein, Hong Kong, Macau, Ecuador, Colombia, Vietnam, and Peru

When using this watch in a country other than one of those listed above, disable the function link by turning off the connection between the watch head and wena 3.

For details, visit our website: https://www.seikowatches.com/jp-ja/customer-service/bluetooth_w

REGULATORY COMPLIANCE

● EU



This product is in compliance with the essential requirements and other relevant provisions of the RE Directive (2014/53/EU) & RoHS Directive (2011/65/EU).

<https://www.seikowatches.com/global-en/products/declaration-conformity>

1. ABOUT THIS PRODUCT

About Bluetooth®

■ Specifications of Bluetooth

- Communication method: Bluetooth Standard Ver. 5.0
- Frequency band used: 2.4 GHz band (2,402 to 2,480 MHz)
- Modulation method: GFSK (1 MHz)

■ Caution for Use of Bluetooth Connection

- The range in which the Bluetooth connection of this product is possible varies depending on obstacles (human bodies, metal, walls, etc.) and the surrounding radio wave state.

Under the following conditions, the Bluetooth connection may take a long time or a connection error may occur.

Places where a wireless LAN exists;

Around microwave ovens in use; and

When other products with a communication function are used.

In such cases, data sending/receiving may fail, however, it is not a malfunction.

Use the product in other environment.

- The radio waves emitted by this product may affect operations of electronic medical equipment, etc.

In some cases, this may lead to serious accidents. Therefore, avoid Bluetooth connections in the following places:

Hospitals; near priority seats in trains; airplanes; places such as gas stations where flammable gas is generated; near automatic doors; and fire alarm systems.

- Note that we are not liable for any information leakage that may occur with the Bluetooth connection.

■ License and Trademark

Bluetooth® is a trademark or registered trademark of Bluetooth SIG, Inc.

Seiko Watch Corporation uses this logo mark under license.

1. ABOUT THIS PRODUCT

Contact Information

Please note that the warranty and contact information are different for the clasp section (wena 3) of this watch. For repair and other concerns, refer to the warranty certificates and the instructions, and contact the respective service centers.

※ Before requesting to have your watch head repaired, be sure to remove the clasp section (wena 3) in the manner illustrated below.

→ How to remove the clasp section (wena 3) P.8

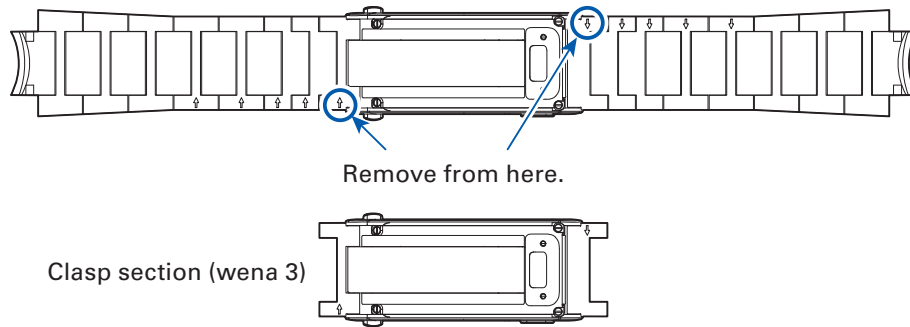

■ Watch head and band (not including wena 3)

Inquiries regarding use, repair, and maintenance of the watch head

SEIKO CUSTOMER SERVICE CENTER
0120-181-671

Reception hours: 9:30-17:30 (Monday through Friday)

For reception hours during the summer and New Year's holidays, please visit our website
(<https://www.seikowatches.com/jp-ja/contact>)

※ If your phone is set to "number withheld," add "186" to the above phone number.

■ Clasp section (wena 3)

Repair inquiries for wena 3

Repair Service Center

Toll-free : **0120-252-645**

Mobile phone/PHS/some IP phones : **050-3754-9592**

Reception hours: 9:30-18:00 (Monday through Friday)

9:30-17:00 (Saturday, Sunday and public holiday)

※ For information other than repair, such as how to use wena 3, refer to the Startup Guide and the Reference Guide supplied with wena 3, and the wena support page.
(<http://wena.jp/support.html>)

1. ABOUT THIS PRODUCT

Removing and attaching the clasp section (wena 3)

How to remove the clasp section (wena 3)

- ① Using the included tool, push out the pin in the direction of the arrow marked on the underside of the link. As illustrated below, insert the tip of the tool into the outer hole of the connecting part of the bended band until the tool can no longer be pushed. The pin will be pushed out. If the pin is hard to remove, bend the band for a few more times and do it over again.

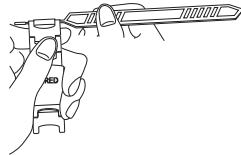

- ② Set the band vertically and draw out the ejected pin. When the pin is removed, the link of the band will be released from the connecting part.

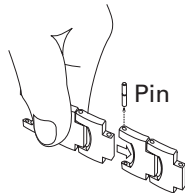

- ③ When the links of the band are released from the connecting part, the spring bar will become loose. When the spring bar does not fall off, gently press it down with the tool.

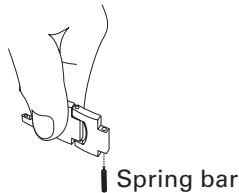

- ④ Repeat the steps ① to ③ to remove the clasp section (wena 3).
※ Save the removed links, pins, spring bars and tool.

※ The design of the band differs from model to model, and the design illustrated above may not be the same as that of your watch.

How to attach the clasp section (wena 3)

- ① Securely insert the spring bar into the inner hole as shown in the illustration.



Be careful not to leave the spring bar protruding from the inner hole, as it may deform or damage the spring bar.

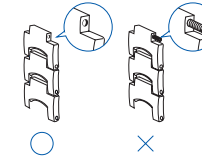

- ② Bend the band outward, and slowly push the pin in.

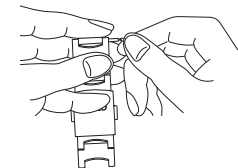

- ③ With the tip of the shorter head of the tool, push the pin in until it is set to the correct position.

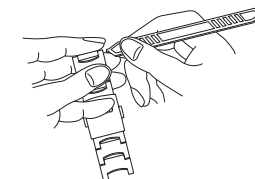

1. ABOUT THIS PRODUCT

Features

This product includes wena 3 provided by Sony Corporation and a watch head capable of operating and displaying the wena 3 functions.

The wena 3 app installed on the smartphone can be set to display the information of wena 3 in a simple way using the indicator hand and to operate part of the functions of wena 3 with the watch head buttons.

■ The information retained by wena 3 can be indicated with the indicator hand of the watch head.

※ The rough ratio or level for the set target value and upper limit amount is displayed.

■ The watch buttons can be used to operate wena 3 and call various settings screens.

■ Incoming calls/mails and notifications received by wena 3 can be indicated with the movement of the hand.

※ To link the watch head with the wena 3 functions, the link head setting on the wena 3 app needs to be set.

※ The wena 3 app supports the following OSs (as of January 2021).
· iOS 11 or later
· Android 6.0 or later

For the latest information on the supported OS, refer to the wena support page.
(<http://wena.jp/support.html>)

Names of Parts

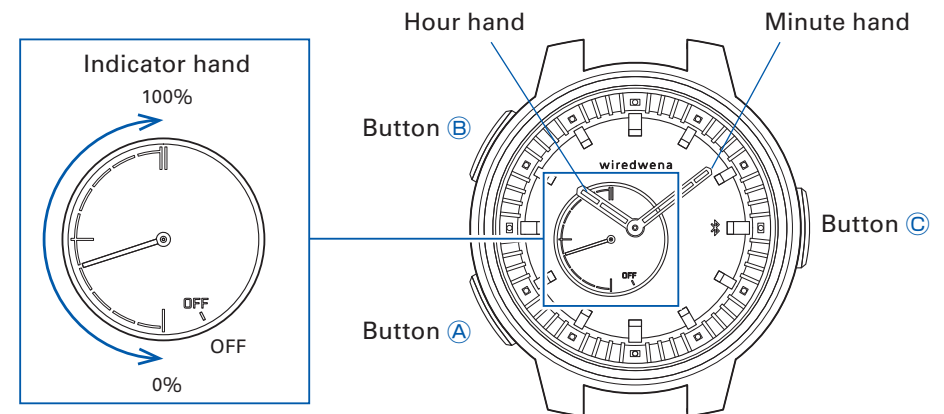

※ The markings on the bezels and the design of the watch may differ from model to model.

1. ABOUT THIS PRODUCT

Functions of This Watch

● With Button **A**, Button **B**, and Button **C**, the operations shown in the illustration below can be performed.

When wena 3 is not connected

- Operation with Button **A**
Time setting with watch buttons (P.17)
Hand position adjustment with watch buttons (P.19)
- Operation with Button **C**
Transition to be ready for connection (P.12)
- Operation with Button **A** and Button **C**
Deleting the pairing on the watch head (P.13)



When wena 3 is connected

- Operation with Button **A**
Execution of functions set in the wena 3 app (P.15)
- Operation with Button **B**
Execution of functions set in the wena 3 app (P.15)
- Operation with Button **C**
Turning off the connection with wena 3 (P.13)

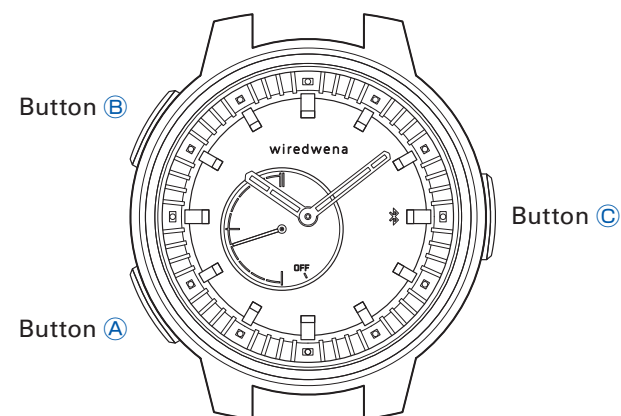

2. Connection of wena 3 and the watch head

Initial Settings (1)

■ Remarks on pairing

Please note the following when pairing wena 3 with the watch head via Bluetooth communication.

Pairing is the process of performing mutual device registration when connecting wena 3 and the watch head for the first time.

CAUTION

- ※ Make sure that the wena 3 app installed on your smartphone is running.
- ※ Connect wena 3 to your smartphone and operate it at a close distance from your watch head.
- ※ Please make sure that there is sufficient remaining battery power in wena 3 and the watch head for pairing.
- ※ In the places where use of radio waves is prohibited, such as in airplanes and hospitals, turn off wena 3 to disconnect the communication between the watch head and wena 3.
- ※ Your watch is compliant with or certified by the radio law of various countries and regions. Use of it in areas other than those may be illegal and subject you to punishment. (Refer to [P.5.](#))

■ Initial setting procedure

When using this product for the first time, perform the following operations and settings.

STEP 1 : Charge wena 3.



STEP 2 : Install the wena 3 app.



STEP 3 : Pair wena 3 with the smartphone.



STEP 4 : Pair wena 3 with the watch head.

For STEP 1 to 3:

Refer to the Startup Guide supplied with wena 3 and the wena support page.

(<http://wena.jp/support.html>)

2. Connection of wena 3 and the watch head

Initial Settings (2)

STEP 4: Pair wena 3 with the watch head.

Pairing between wena 3 and the watch head cannot be performed if registration information is left on either of the devices.

If registration information still remains on either of the devices, delete the pairing on both devices before proceeding. (Refer to “When connection with wena 3 cannot be achieved” on P.13.)

- 1 Set “Connect watch head setting” on the wena 3 app. Tap ≡ (Menu) > “Device settings” > “Connect watch head setting”. Follow the screen instructions to proceed with the connection operation.
 - ※ When the link head setting is complete, “connect watch head” is displayed in “settings” on the tool screen of wena 3.
- 2 Press and hold the watch Button **C** for 2 seconds or more. The watch head is ready for connection, and the indicator hand moves back and forth between “OFF” and 0% for 60 seconds.

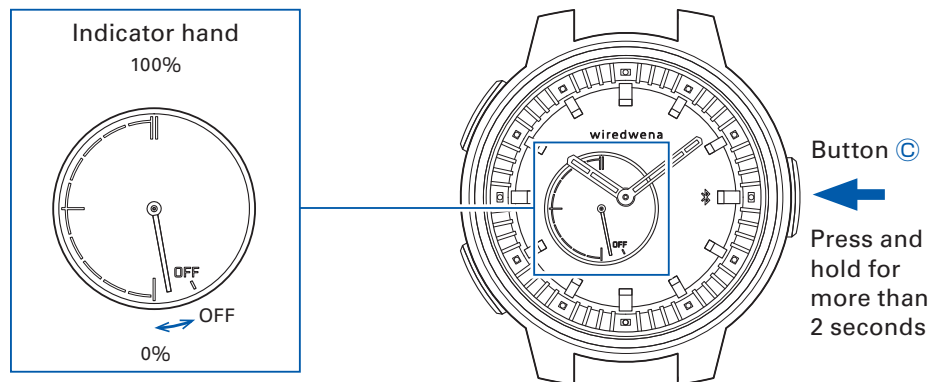

Press and hold Button **C** for more than 2 seconds

- 3 Press the power button of wena 3 to display the home screen.

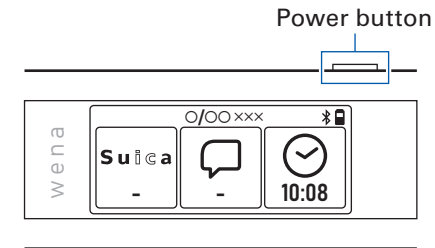

- 4 On the tool screen of wena 3, tap “settings” > “connect watch head”. Swipe the home screen down to display the tool screen. Swipe the screen left to display the “settings” icon.

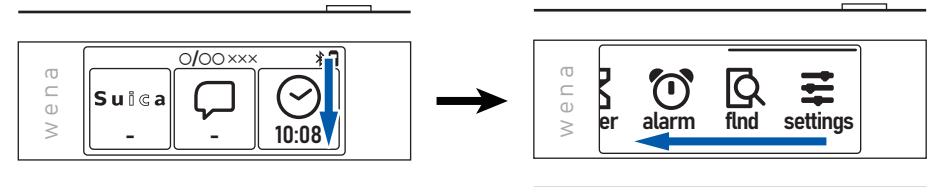

※ The display contents of wena 3 shown above are examples.

- 5 On the screen that displays “Pair with watch head.”, tap “OK”. When the pairing is successful, “completed” is displayed on wena 3 and the indicator hand moves to a location between 0% and 100%.
 - ※ Perform this step while the watch head is ready for connection (while the indicator hand of the watch head is moving back and forth between “OFF” and 0%).

This completes pairing of wena 3 with the watch head.

2. Connection of wena 3 and the watch head

How to Disconnect, Reconnect, and Delete Pairing

■ Turning off the connection with wena 3

To adjust the time manually (refer to P.17), correct the hand positions (refer to P.19), and delete pairing (refer to P.13), the connection with wena 3 must be turned off.

- 1 Press and hold Button **C** of the watch head for 2 seconds or more. The indicator hand moves to the OFF position.

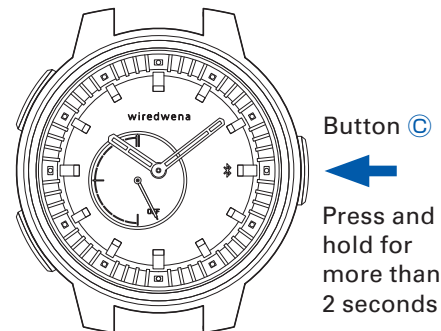

■ Reconnecting with wena 3

To reconnect the watch head with wena 3 after having disconnected it, perform the following procedure.

- 1 Press and hold the watch Button **C** for 2 seconds or more. The watch head is ready for connection, and the indicator hand moves back and forth between "OFF" and 0% for 60 seconds.
 - 2 Press the power button of wena 3 to display the home screen.
 - 3 On the tool screen of wena 3, tap "settings" > "connect watch head".
 - 4 On the screen that displays "Already paired. Connect with watch head.", tap "connect".
- When the reconnection is successful, "completed" is displayed on wena 3 and the indicator hand moves to a location between 0% and 100%.

※ Perform this step while the watch head is ready for connection (while the indicator hand of the watch head is moving back and forth between "OFF" and 0%).

■ When connection with wena 3 cannot be achieved

When connection of the watch head with wena 3 cannot be achieved, delete the pairing on both devices and then pair them again.

[Deleting the pairing on the watch head]

- 1 Press and hold both Button **A** and Button **C** of the watch head until the hour hand and minute hand move to the 3 o'clock position and stop. When the pairing is successfully deleted, the hour hand and minute hand will stop at the 3 o'clock position for 5 seconds, and then display the current time.

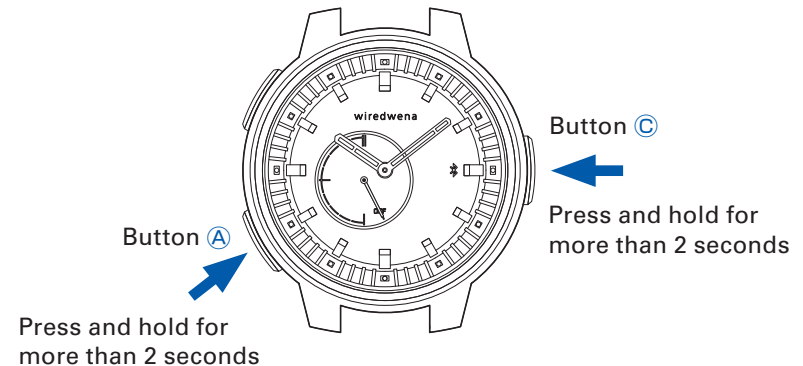

[Deleting the pairing on wena 3]

- 1 On the tool screen of wena 3, tap "settings" > "connect watch head".
 - 2 On the screen that displays "Already paired.", tap "Delete".
 - 3 On the screen that displays "Would you like to unpair the watch head?", tap "OK".
- When the pairing is successfully deleted, "completed" is displayed on wena 3.

After deleting the pairing, perform "STEP 4: Pair wena 3 with the watch head" (P.12) again.

3. Function link with wena 3

Function Link (1)

How to set the function link

The wena 3 app can be used to set the contents to be indicated by the indicator hand, as well as the functions to be activated when the watch button is pressed once or is pressed and held for 1 second or more.

- ① Display "Connect watch head setting" on the wena 3 app. Tap ≡ (Menu) > "Device settings" > "Connect watch head setting". The settings screen for the function link is displayed.
- ② Set the function link. Tap the ▼ symbol for the indicator hand and each button to select and set the function.

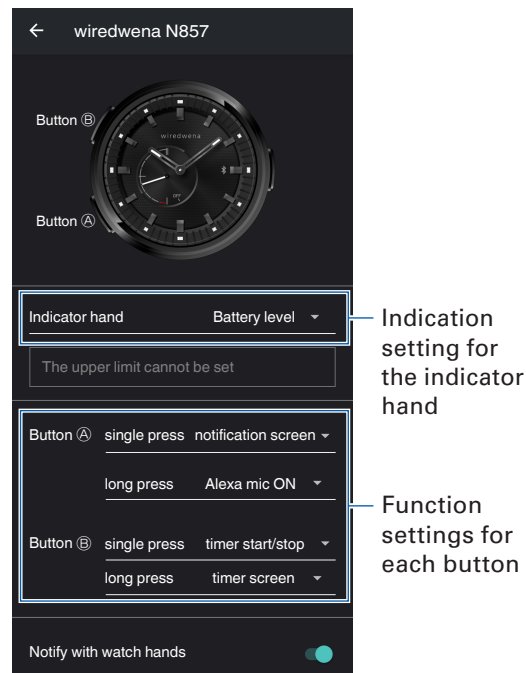

Indication setting for the indicator hand

Function settings for each button

※ The setting items for the link function are those as of January 2021. The selection items may be changed with the version upgrade of the wena 3 main unit.

● Indication setting for the indicator hand

The following information of wena 3 can be set to the indicator hand.

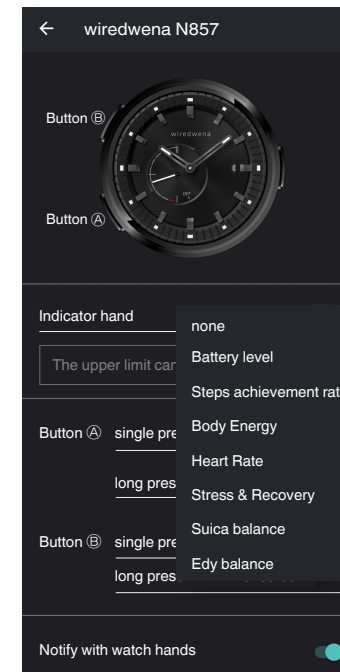

Setting item	Display content
Battery level	Displays the ratio of remaining battery power in wena 3.
Steps achievement rate	Displays the ratio of target achievement rate for the set goal of steps to be taken per day.
Body Energy	Displays the ratio of activity energy status.
Heart Rate	Displays the ratio of the measured heart rate for the set upper limit value.
Stress & Recovery	Displays the ratio of the stress level. 0-50%: Relaxed, 50-100%: Stressed
Suica balance	Displays the ratio of Suica balance for the set balance upper limit.
Edy balance	Displays the ratio of Edy balance for the set balance upper limit.

3. Function link with wena 3

Function Link (2)

● Function settings for each button

The function to be enabled by pressing each button can be set.

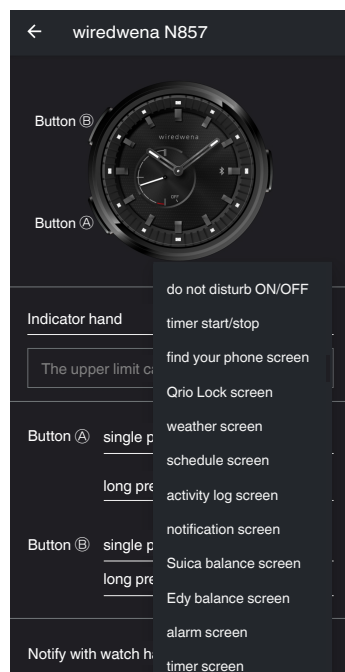

For the following items, pressing the button activates the wena 3 function.

Setting item	Operation function
Alexa mic ON	Turns ON the wena 3 microphone that links to Alexa.
Qrio Lock-unlock Qrio Lock-lock	Unlocks or locks smart locks such as entrance doors.
NFC ON/OFF	Turns ON/OFF the NFC function of wena 3.
do not disturb ON/OFF	Turns ON/OFF the vibration motor of wena 3.
timer start/stop	Starts/stops the timer function of wena 3.

● For the following items, pressing the button calls the wena 3 screen.

- find your phone screen
- Qrio Lock screen
- weather screen
- schedule screen
- activity log screen
- notification screen
- Suica balance screen
- Edy balance screen
- alarm screen
- timer screen

The initial settings for individual items are as follows.

Item	Initial value	
Indicator hand	battery level	
Button A	single press	notification screen
	long press	Alexa mic ON
Button B	single press	timer start/stop
	long press	timer screen
Notify with watch hands	ON	

※ The setting items for the link function are those as of January 2021. The selection items may be changed with the version upgrade of the wena 3 main unit.

■ Automatic time synchronization function

If the watch head, wena 3, and the smartphone on which the wena 3 app is installed are connected correctly, the time will be synchronized automatically at regular intervals.

■ Sleep & Alarm Settings

When "Automatic power off time settings" in "Sleep & Alarm Settings" is set to ON in "Device settings" in the wena 3 app, the connection between wena 3 and the watch head is turned off during the set time.

※ During the time set in "Sleep & Alarm Settings", automatic time synchronization and notification of incoming calls/mails and notifications received by wena 3 do not work.

3. Function link with wena 3

Function Link (3)

■ How to use the function link

● Example of indicating the information of wena 3 on the watch head

● Displaying the account balance ratio of electronic money on the watch head

From the “Connect watch head setting” menu of the wena 3 app, set “Suica balance” or “Edy balance” for the indicator hand and input the upper limit value of the account balance. The account balance ratio of electronic money is displayed for the set upper limit value.

Ex.) When the upper limit value of the indicator hand is set to 10,000 yen and the balance is 5,000 yen, the indicator hand indicates 50%.

[Setting procedure]

- ① Display “Connect watch head setting” in the wena 3 app on your smartphone.
Tap ≡ (Menu) > “Device settings” > “Connect watch head setting”.
The settings screen for the function link is displayed.
- ② Tap the ▼ symbol for the indicator hand to select “Suica balance” or “Edy balance”, and enter the upper limit.
If the upper limit is not input, the initial value is as follows.
 - Edy: 50,000 yen
 - Suica: 20,000 yen

● Displaying the target achievement rate for the goal of steps to be taken per day on the watch head

From the “Connect watch head setting” menu of the wena 3 app, set “Steps achievement rate” for the indicator hand.

The target number of steps per day is set in ≡ (Menu) > “Device settings” > “Activity settings”.

If the target number of steps is not input, the initial value is 10,000 steps.

The current target achievement rate for the set goal of steps to be taken is displayed.

Ex.) If the target number of steps per day is 10,000 and the current number of steps is 7,000, the indicator hand indicates 70%.

[Setting procedure]

- ① Display “Connect watch head setting” in the wena 3 app on your smartphone.
Tap ≡ (Menu) > “Device settings” > “Connect watch head setting”.
The settings screen for the function link is displayed.
- ② Tap the ▼ symbol for the indicator hand to select “Steps achievement rate”.

For details on other items that can be displayed by the indicator hand, refer to the wena support page.
(<http://wena.jp/support.html>)

4. MANUAL TIME ADJUSTMENT FUNCTION

How to Adjust Time Manually (1)

- If for some reason the time synchronization function by Bluetooth communication with wena 3 cannot be used, such as when the battery of wena 3 runs out, the time can be adjusted on the watch head alone.

※ To adjust the time manually, the connection with wena 3 must be turned off.

Press and hold Button © for 2 seconds or more to turn off the connection with wena 3, and then adjust the time manually.

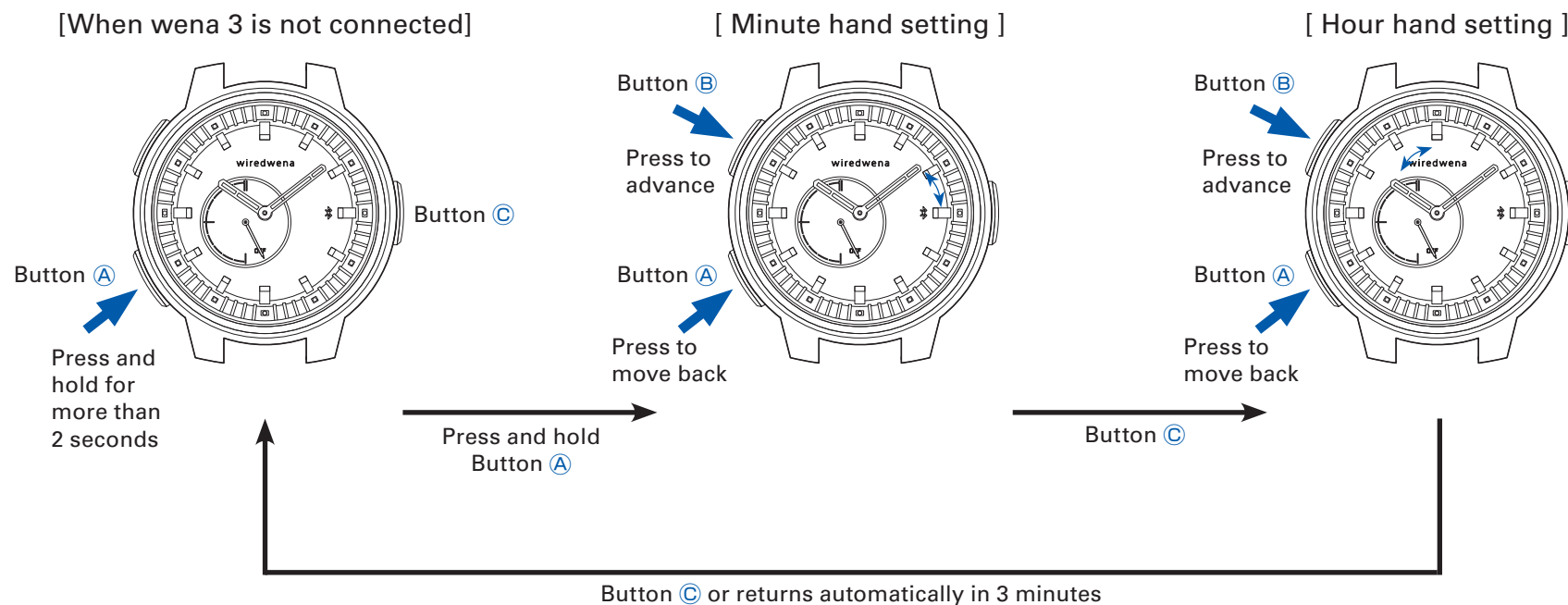

4. MANUAL TIME ADJUSTMENT FUNCTION

How to Adjust Time Manually (2)

■ Operation Method

- ① Check that the indicator hand points to the OFF position and wena 3 and the watch head are disconnected.
If the watch head is connected to wena 3, press and hold Button ③ for 2 seconds or more to disconnect the watch head from wena 3, and check that the indicator hand is pointing to OFF.
- ② Press and hold Button ① for more than 2 seconds to activate the manual time setting function.
The minute hand moves to the "0 second" position of the minute next to the one currently displayed. Then, the minute hand moves to indicate that it is ready for setting.
[Ex.) If the time is 10:08 PM when the time adjustment function is activated]
By pressing and holding Button ① for more than 2 seconds, the hour and minute hands move to the positions indicating "10:09 00."
- ③ Press Button ② or ④ to set the minute hand.
※ With each press of Button ④ or ②, the minute hand advances or moves back 1 minute, respectively. It moves quickly if the respective buttons are kept pressed.
- ④ After the minute hand setting is completed, press Button ③.
The hour hand moves to indicate that it is ready for setting.
- ⑤ Press Button ② or ④ to set the hour hand.
※ With each press of Button ④ or ②, the hour hand advances or moves back 1 hour, respectively. It moves quickly if the respective buttons are kept pressed.
- ⑥ After all the time setting procedure is completed, press Button ③ in accordance with a time signal. The time is set and the display returns to the time. If the watch is left untouched for 3 minutes, the time setting function is also deactivated, and the time you have set is registered.
※ Even if the time is adjusted manually, the watch head will display the time obtained in synchronizing with wena 3 if it is connected to wena 3.

5. HAND POSITION ADJUSTMENT

How to Adjust Hand Position (1)

- In the following cases, the positions of the hands stored in the built-in IC of the watch head and the actually displayed positions of the hands may be misaligned.

Follow the procedure below to check and adjust the hand positions.

- The hands do not point to the proper positions, being affected by strong shocks, magnetism.
- The correct time is not displayed even though communication with wena 3 and time synchronization are performed.

※ To adjust the hand positions, the connection with wena 3 must be turned off.

Press and hold Button C for 2 seconds or more to turn off the connection with wena 3, and then adjust the hand positions.

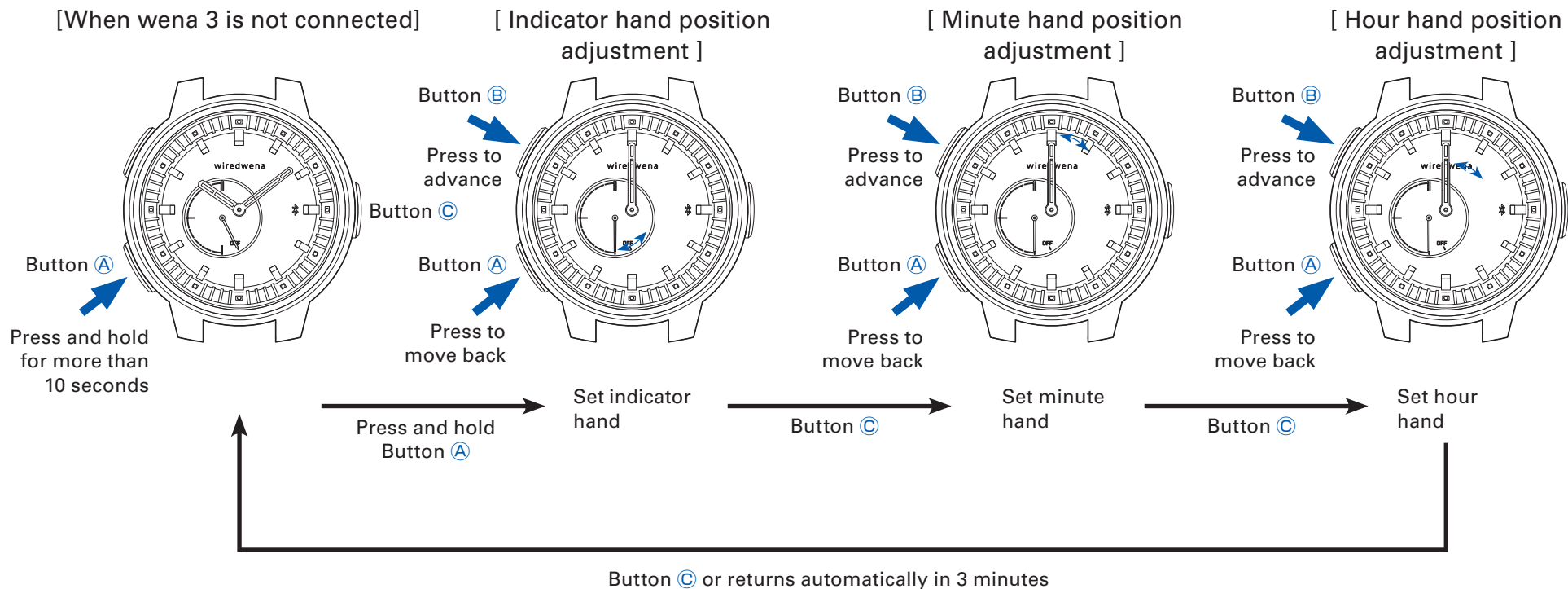

5. HAND POSITION ADJUSTMENT

How to Adjust Hand Position (2)

■ Operation Method

- ① Check that the indicator hand points to the OFF position and wena 3 and the watch head are disconnected.
If the watch head is connected to wena 3, press and hold Button **C** for 2 seconds or more to disconnect the watch head from wena 3, and check that the indicator hand is pointing to OFF.
- ② Press and hold Button **A** for more than 10 seconds. The hand position adjustment function is activated, and the hour hand and minute hand move to the 12 o'clock position, and the indicator hand moves significantly before finally stopping at the 0% position. Then, the indicator hand moves to indicate that it is ready for indicator hand position adjustment. If the hour hand, minute hand or indicator hand is misaligned, adjust the hand position using the following method.
 - ※ While Button **A** is kept pressed to activate the hand position adjustment function, the minute hand setting display of the manual time setting function appears temporarily. Be sure to keep the button pressed for more than 10 seconds until the hour and minute hands move toward the 12 o'clock position and the indicator hand stops at the 0% position. (Refer to "How to Adjust Time Manually (1)" on P.17.)
- ③ Press Button **A** or Button **B** to set the indicator hand to the 0% position.
 - ※ With each press of Button **B** or **A**, the indicator hand advances or moves back, respectively. It moves quickly if the respective buttons are kept pressed.
- ④ After the indicator hand position adjustment is completed, press Button **C**.
The minute hand moves to indicate that it is ready for minute hand position adjustment.
- ⑤ Press Button **A** or **B** to set the minute hand to the 12 o'clock position.
 - ※ With each press of Button **B** or **A**, the minute hand advances or moves back, respectively. It moves quickly if the respective buttons are kept pressed.
- ⑥ After the minute hand position adjustment is completed, press Button **C**.
The hour hand moves to indicate that it is ready for hour hand position adjustment.
- ⑦ Press Button **A** or **B** to set the hour hand to the 12 o'clock position.
 - ※ With each press of Button **B** or **A**, the hour hand advances or moves back, respectively. It moves quickly if the respective buttons are kept pressed.
- ⑧ After the hour hand position adjustment is completed, press Button **C**. The hand position adjustment function is deactivated, and the display returns to the time. If the watch is left untouched for 3 minutes, the hand position adjustment function is also deactivated, and the hand position you have set is registered.

6. TO PRESERVE THE QUALITY OF YOUR WATCH

Daily Care

● The watch requires good daily care.

- Wipe away moisture, sweat or dirt with a soft cloth.
- After soaking the watch in seawater, be sure to wash the watch in clean pure water and wipe it dry carefully.

Do not pour running water directly from faucet onto the watch. Put some water into a bowl first, and then soak the watch in the water to wash it.

※ If your watch is rated as “Non-water resistant” or “Water resistant for everyday life,” do not wash the watch.

→ “Performance and Type” on [P.21](#)

→ “Water Resistance” on [P.22](#)

Performance and Type

● The case back shows the caliber No. and performance of your watch.

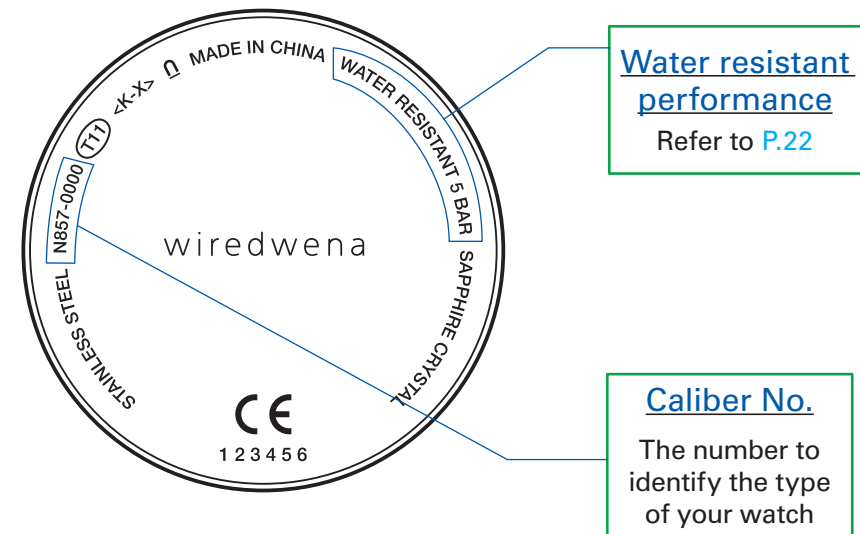

※ The case back design differs from model to model, and the case back illustrated above may not be the same as that of your watch.

6. TO PRESERVE THE QUALITY OF YOUR WATCH

Water Resistance

Refer to the table below for the water resistant performance of your watch before use.

(Refer to [P.21.](#))

Indication on the Case Back	Water Resistant Performance	Condition of Use
No indication	Non-water resistance	Avoid drops of water or sweat
WATER RESISTANT	Water resistance for everyday life	The watch withstands accidental contact with water in everyday life.  WARNING Not suitable for swimming
WATER RESISTANT 5 BAR	Water resistance for everyday life at 5 barometric pressures	The watch is suitable for sports such as swimming.
WATER RESISTANT 10 (20) BAR	Water resistance for everyday life at 10 (20) barometric pressures	The watch is suitable for diving not using an air cylinder.

6. TO PRESERVE THE QUALITY OF YOUR WATCH

Band

The band touches the skin directly and becomes dirty with sweat or dust. Therefore, lack of care may accelerate deterioration of the band or cause skin irritation or stain on the sleeve edge. The watch requires a lot of attention for longer use.

● **Metallic band**

- Moisture, sweat or soil will cause rust even on a stainless steel band if they are left for a long time.
- Lack of care may cause a yellowish or gold stain on the lower sleeve edge of shirts.
- Wipe off moisture, sweat or soil with a soft cloth as soon as possible.
- To clean the soil around the joint gaps of the band, wipe it out in water and then brush it off with a soft toothbrush.
(Protect the watch body from water splashes by wrapping it up in plastic wrap etc.) Wipe off the remaining moisture with a soft cloth.
- Because some titan bracelets use pins made of stainless steel, which has outstanding strength, rust may form in the stainless steel parts.
- If rust advances, pins may poke out or drop out, and the watch case may fall off the bracelet, or the clasp may not open.
- If a pin is poking out, personal injury may result. In such a case, refrain from using the watch and request repair.

● **Leather band**

- A leather band is susceptible to discoloration and deterioration from moisture, sweat and direct sunlight.
- Wipe off moisture and sweat as soon as possible by gently blotting them up with a dry cloth.
- Do not expose the watch to direct sunlight for a long time.
- Please take care when wearing a watch with light-colored band, as dirt is likely to show up.
- Refrain from wearing a leather band watch other than Aqua Free bands while bathing, swimming, and when working with water even if the watch itself is water-resistant enforced for daily use (10- or 20-BAR water resistant).

● **Silicone band**

- As for material characteristics, the band is easily dirtied, and may be stained and discolored. Wipe off dirt with a wet cloth or cleaning tissue.
- Unlike bands of other materials, cracks may result in the band being cut. Take care not to damage the band with an edged tool.

● **Polyurethane band**

- A polyurethane band is susceptible to discoloration from light, and may be deteriorated by solvent or atmospheric humidity.
- Especially a translucent, white, or pale colored band easily adsorbs other colors, resulting in color smears or discoloration.
- Wash out dirt in water and clean it off with a dry cloth.
(Protect the watch body from water splashes by wrapping it up in plastic wrap etc.)
- When the band becomes less flexible, have the band replaced with a new one. If you continue to use the band as it is, the band may develop cracks or become brittle over time.

Notes on skin irritation and allergy

Skin irritation caused by a band has various reasons such as allergy to metals or leathers, or skin reactions against friction on dust or the band itself.

Notes on the length of the band

Use the band with just a little slack for breathability.
When using the heart rate function of wena 3, sufficiently close contact is required to ensure that the heartrate sensor surface is correctly oriented.



6. TO PRESERVE THE QUALITY OF YOUR WATCH

Remarks on Battery

1. Notes on the battery

(1) Battery life

This watch keeps operating for approximately 2 years if a new normal battery is inserted in it.

※ However, the battery life (2 years) is based on 24 hours of communication connection with wena 3, 10 button operations, and 10 display hand notifications per day. If used more than that, the battery of the watch may run out in less than 2 years.

(2) Monitor battery

The battery in your watch is a monitor battery which is inserted at the factory to check the function and performance of the watch. Its actual life once in your possession may be less than the specified period.

(3) Battery replacement

- For battery replacement, be sure to have the battery replaced with a new one at the retailer from whom the watch was purchased, specifying a genuine SEIKO battery.
- If the old battery is left in the watch for a long time, a malfunction may be caused due to battery leakage, etc. Have it replaced with a new one as soon as possible.
- Battery replacement is made at cost even if it runs down within the guarantee period.
- Once the case back is opened for battery replacement or other purposes, the original water resistant quality designed for the watch may deteriorate when it is closed. When you have the battery replaced with a new one, also request the water resistance test suitable for the water resistant quality of your watch. If your watch has 10-bar or higher water resistant quality, be sure to have such test performed on the watch every time the battery is replaced. Please note that it takes several days to check the water resistant quality of your watch. When requesting the checking, therefore, please confirm the period required for it.
- If the watch stops operating soon after the battery is replaced with a new one, it needs to be overhauled. (Refer to [P.25](#).)

2. Battery life indicator

The watch is equipped with a battery life indicator that enables you to know when the battery needs to be replaced.

When the indicator hand points to 3 o'clock, button operation is disabled, and communication with wena 3 cannot be performed, the watch may stop in a week or so.

Immediately request the retailer from whom the watch was purchased to replace the battery with a new one.

3. Initial setup after replacing battery

After replacing the battery, be sure to perform a system reset operation (refer to [P.30](#)) and configure the hand position adjustment and pair the watch head with wena 3 again.

At this time, it is necessary to delete the pairing on both wena 3 and the watch head (refer to [P.13](#)).



WARNING

- Do not open the case back to take out the battery.
- If the battery is removed from the case back for any unavoidable reason, put it in a place beyond the reach of children. If it is swallowed by a child, consult the doctor immediately.



CAUTION

- Never short-circuit, heat or disassemble the battery. Never put it close to a fire. It may explode, generate an intense heat or catch fire.
- The battery inserted in your watch is not rechargeable. Never attempt to recharge it. If it is recharged accidentally, it may explode.
- Use only the battery specified for your watch. If a battery other than specified is inserted in the watch, it may explode.
- When disposing of an old battery, observe the regulations of the local authorities concerned.

6. TO PRESERVE THE QUALITY OF YOUR WATCH

After-Sales Service

Please note that the warranty and contact information are different for the clasp section (wena 3) of this watch. For repair and other concerns, refer to the warranty certificates and the instructions, and contact the respective service centers. (Refer to [P.7.](#))

The following after-sales service terms apply to the watch head and the band (not including wena 3).

● Notes on guarantee and repair

- Contact the retailer from whom the watch was purchased or SEIKO CUSTOMER SERVICE CENTER for repair or overhaul.
- Within the guarantee period, present the certificate of guarantee to receive repair services.
- Guarantee coverage is provided in the certificate of guarantee. Read carefully and retain it.
- For repair services after the guarantee period has expired, if the functions of the watch can be restored by repair work, we will undertake repair services upon request and payment.

● Replacement parts

- SEIKO makes it a policy to typically keep a stock of replacement parts for this watch for 7 years. Replacement parts are those which are essential to maintaining the functional integrity of the watch.
- Please note that if original parts are not available, they may be replaced with substitutes whose external appearance may differ from the originals.

● Disassembly and cleaning (overhaul) for checking and adjustment purpose

It is recommended that disassembly and cleaning (overhaul) for checking and adjustment purpose be performed periodically approximately once every 3 to 4 years, in order to maintain optimal performance of the watch for a long time.

- The watch is a precision device. It may stop operating or lose time if its parts run low on oil or wear out.
- The watch may also stop operating due to battery leakage depending on the condition of use.
- Its water resistant quality may be impaired due to entry of perspiration or moisture as the gasket or other parts deteriorate.

If any of the above should occur, please contact the retailer from whom the watch was purchased for disassembly and cleaning (overhaul) for checking and adjustment purpose. For replacement of parts, please specify "SEIKO GENUINE PARTS." When requesting overhaul, be sure to have the gasket and push pin replaced with new ones.

※Please note that the movement of your watch may be replaced with a new one when it is overhauled.

7. TROUBLESHOOTING

Troubleshooting (1)

■ Basic Operations

Problem	Possible Cause	Solution	Refer to
The watch has stopped operating.	The battery has run down.	Immediately request the retailer from whom the watch was purchased to replace the battery with a new one.	P.11, 30 of this Instruction Manual
The indicator hand points to 3 o'clock, button operation is disabled, and communication with wena 3 cannot be performed.	The battery voltage is low. The battery nears its end.	After replacing the battery, perform a system reset of the watch head and delete the pairing information of wena 3 (refer to "How to Reset Built-In IC (System Reset)"), and then pair the watch head with wena 3 again according to the "Initial Settings" procedure.	
Pairing with wena 3 has failed.	The watch head is not ready for connection.	Press and hold Button © of the watch head for 2 seconds or more to be ready for connection (the indicator hand starts to move back and forth).	P.12 of this Instruction Manual
	The watch head connection function of wena 3 is not ON.	When the watch head is ready for connection (the indicator hand is moving back and forth), proceed to "settings" > "connect watch head" > "Pair with watch head." on wena 3, and then tap "OK" to set the watch head connection function ON. When "Already paired." appears, tap "delete" and delete the pairing information before performing the operation above.	P.12, 13 of this Instruction Manual
	The item "connect watch head" is not displayed on wena 3.	On the wena 3 app, tap "Device settings" and perform "Connect watch head setting" to complete the link head setting.	P.12 of this Instruction Manual
	Pairing is incorrect.	Delete the pairing information from the watch head and wena 3 respectively, and try the pairing operation again.	P.12, 13 of this Instruction Manual
	wena 3 and the watch head are far from each other.	Please connect wena 3 to the band before use.	P.8 of this Instruction Manual
The time on the watch head is not accurate.	wena 3 and the watch head are not connected.	Connect the watch head with wena 3 or manually adjust the time.	P.12, 17 of this Instruction Manual
	The time on wena 3 is not accurate.	Connect wena 3 to the smartphone, and tap the update button on the wena 3 app to correctly adjust the time on wena 3.	
	The hands have become misaligned from the original position due to strong magnetism, shock or other external cause.	Disconnect the watch head from wena 3 and check the original positions of the hands in the hand position adjustment mode. If the original position is misaligned, adjust it to the correct position.	P.19 of this Instruction Manual

7. TROUBLESHOOTING

Troubleshooting (2)

Problem	Possible Cause	Solution	Refer to
wena 3 is disconnected. The indicator hand points the OFF position.	Pairing is incorrect.	Delete the pairing information from the watch head and wena 3 respectively, and try the pairing operation again.	P.12, 13 of this Instruction Manual
	Disconnection has occurred due to the impact from devices that generate strong radio waves.	Set the watch head to be ready for connection (press and hold Button © for 2 seconds or more), and then tap "settings" > "connect watch head" of wena 3 to enable the watch head connection function.	P.12 of this Instruction Manual
	"Automatic power off time settings" in "Sleep & Alarm Settings" is ON.	Connection with wena 3 is disabled when "Sleep & Alarm Settings" is ON and within the time set in "Automatic power off time settings". Turn "Automatic power off time settings" in "Sleep & Alarm Settings" OFF or change the set time.	P.15 of this Instruction Manual
	wena 3 and the watch head are far from each other.	Please connect wena 3 to the band before use.	P.8 of this Instruction Manual
The indicator hand does not move even when the smartphone receives notifications.	The link head setting on the wena 3 app is not completed.	On the wena 3 app, tap "Device settings" and perform "Connect watch head setting" to complete the link head setting.	P.12 of this Instruction Manual
	The app for receiving notifications is not set on wena 3.	On the wena 3 app, tap "Device settings" and then "Notification settings", and configure the notification app settings.	
	The notification link function is set to OFF.	On the wena 3 app, tap "Device settings" and then "Connect watch head setting", and set "Notify with watch hands" to ON.	
	wena 3 and the watch head are far from each other.	Please connect wena 3 to the band before use.	P.8 of this Instruction Manual
The hand positions cannot be adjusted.	The watch head is connected with wena 3.	Disconnect the watch head from wena 3 and then adjust the hand positions.	P.19 of this Instruction Manual
	The indicator hand points to 3 o'clock.	Immediately request the retailer from whom the watch was purchased to replace the battery with a new one. After replacing the battery, perform a system reset of the watch head and delete the pairing information of wena 3 (refer to "How to Reset Built-In IC (System Reset)"), and then pair the watch head with wena 3 again according to the "Initial Settings" procedure.	P.11, 30 of this Instruction Manual
Manual time adjustment is not possible.	The watch head is connected with wena 3.	Disconnect the watch head from wena 3 and then manually adjust the time. ※While the watch head is connected to wena 3, it displays the same time as wena 3.	P.17 of this Instruction Manual
	The indicator hand points to 3 o'clock.	Immediately request the retailer from whom the watch was purchased to replace the battery with a new one. After replacing the battery, perform a system reset of the watch head and delete the pairing information of wena 3 (refer to "How to Reset Built-In IC (System Reset)"), and then pair the watch head with wena 3 again according to the "Initial Settings" procedure.	P.11, 30 of this Instruction Manual

7. TROUBLESHOOTING

Troubleshooting (3)

Problem	Possible Cause	Solution	Refer to
Pairing deletion is not possible.	The watch head is connected with wena 3.	Disconnect the watch head from wena 3 and delete the pairing.	P.13 of this Instruction Manual
	The indicator hand points to 3 o'clock.	Immediately request the retailer from whom the watch was purchased to replace the battery with a new one. After replacing the battery, perform a system reset of the watch head and delete the pairing information of wena 3 (refer to "How to Reset Built-In IC (System Reset)"), and then pair the watch head with wena 3 again according to the "Initial Settings" procedure.	P.11, 30 of this Instruction Manual

Indicator Hand

Problem	Possible Cause	Solution	Refer to
The indicator hand points to the OFF position.	wena 3 and the watch head are not connected.	Connect the watch head with wena 3.	P.12 of this Instruction Manual
The indicator hand does not move from 0%.	The indicator hand is not set.	Update the indicator hand settings from the wena 3 app.	P.14 of this Instruction Manual
The indicator hand is not in the correct position.	The hand position is incorrect.	Disconnect the watch head from wena 3 and then adjust the hand positions.	P.19 of this Instruction Manual
The indicator hand points to an incorrect value.	The display item selected on wena 3 is not set correctly.	Set the display item in the wena 3 app again and then press the update button on the home screen of the wena 3 app.	P.14 of this Instruction Manual
The heart rate cannot be displayed, or the displayed value is incorrect.	The heartrate sensor is not properly attached to the arm. (The heart rate and stress level are displayed in 10% increments.)	When measuring your heart rate, keep the heartrate sensor in stable contact with your skin. If the heartrate sensor is not in stable contact with your skin, accurate measurement may not be possible.	
The stress level cannot be displayed, or the displayed value is incorrect.			
The Suica balance cannot be displayed, or the displayed value is incorrect.	Suica and Edy are not set in the wena 3 app.	Make the initial settings for Suica and Edy in the wena 3 app.	
The Edy balance cannot be displayed, or the displayed value is incorrect.			

7. TROUBLESHOOTING

Troubleshooting (4)

■ Button Functions

Problem	Possible Cause	Solution	Refer to
Button functions are not executed. Different functions are performed.	The function selected in wena 3 is not set correctly.	Set the button function in the wena 3 app again and press the update button on the home screen of the wena 3 app.	P.15 of this Instruction Manual
	wena 3 and the watch head are not connected.	Connect the watch head with wena 3.	P.12 of this Instruction Manual
	wena 3 and the watch head are far from each other.	Please connect wena 3 to the band before use.	P.8 of this Instruction Manual
Alexa mic ON cannot be started.	Alexa/Qrio is not set in the wena 3 app.	Make the initial settings of Alexa/Qrio in the wena 3 app.	
Qrio Lock unlocking/locking is not possible.			
The timer cannot be started.	The timer value is not set in wena 3.	Use wena 3 to set the timer value.	

■ Other

Problem	Possible Cause	Solution	Refer to
The indicator hand operation is delayed in relation to smartphone notification.	Communication is delayed.	Due to the specifications of the communication function, a delay of several seconds may occur.	
Any of the hands do not point to its proper position. Ex.) The hands do not indicate the time properly.	The hands have become misaligned from the original position due to strong magnetism, shock or other external cause.	Disconnect the watch head from wena 3 and check the original positions of the hands in the hand position adjustment mode. If any of the hands do not point to the 12 o'clock position exactly, adjust its hand position.	P.19 of this Instruction Manual
Blur on the watch glass persists.	Water has entered inside the watch due to a deteriorated gasket or for any other reason.	Consult the retailer from whom the watch was purchased.	

7. TROUBLESHOOTING

How to Reset Built-In IC (System Reset) (1)

- If the watch behaves abnormally or if the battery has been replaced, perform a system reset using the following procedure. After the system reset is performed, the time returns to its default setting. Be sure to set the time properly before use.

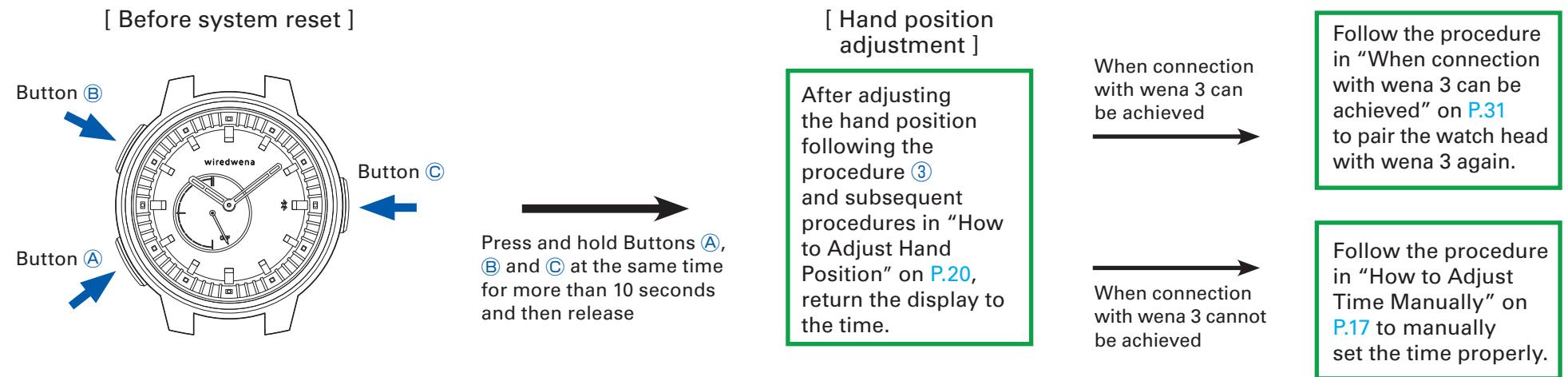

■ Operation Method

- ① Press and hold Buttons A, B, and C at the same time for more than 10 seconds and then release to reset the built-in IC (system reset). The hour hand, minute hand, and indicator hand continue moving for a while. When all hands stop, it is ready for hand position adjustment. If the hands do not move, retry pressing and holding the three buttons at the same time for more than 10 seconds.
- ② Follow the procedure ③ and subsequent procedures in “How to Adjust Hand Position” on P.20 to set the misaligned hands exactly in position.
- ③ After the hand position adjustment of all the hands is completed, press Button C to return to the time display.
 - ※ After the system reset procedure, the watch will not return to the time display automatically in 3 minutes.
 - ※ The watch starts indicating the time from the default setting below:
Time : AM12 : 00 : 00
Indicator hand : OFF

7. TROUBLESHOOTING

How to Reset Built-In IC (System Reset) (2)

● When connection with wena 3 can be achieved

When connection with wena 3 can be achieved, pair the watch head and wena 3 again.

Prior to re-pairing, the pairing must be deleted on both wena 3 and the watch head.

[Deleting the pairing on the watch head]

- 1 Press and hold both Button **A** and Button **C** of the watch head until the hour hand and minute hand move to the 3 o'clock position and stop.

When the pairing is successfully deleted, the hour hand and minute hand will stop at the 3 o'clock position for 5 seconds, and then display the current time.

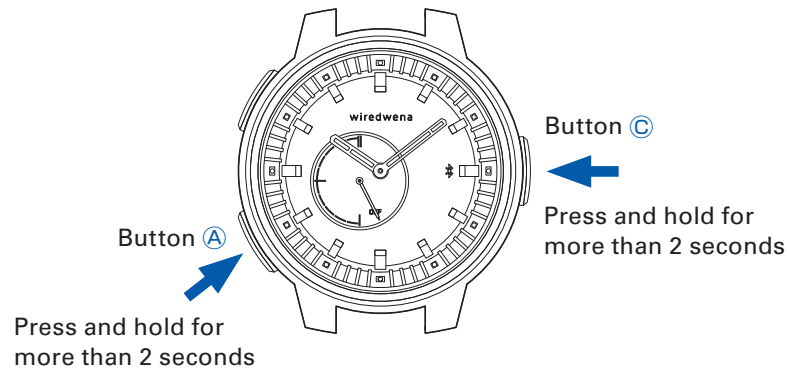

[Deleting the pairing on wena 3]

- 1 On the tool screen of wena 3, tap "settings" > "connect watch head".
- 2 On the screen that displays "Already paired.", tap "Delete".
- 3 On the screen that displays "Would you like to unpair the watch head?", tap "OK".

When the pairing is successfully deleted, "completed" is displayed on wena 3.

After deleting the pairing, perform "STEP 4: Pair wena 3 with the watch head" (P.12) again.

If re-pairing is successful, the time on the watch head will be displayed in synchronization with the time of wena 3.

● When connection with wena 3 cannot be achieved

When connection with wena 3 cannot be achieved, set the correct time manually. (Refer to "How to Adjust Time Manually" on P.17.)

8. SPECIFICATIONS

Specifications

1. Basic functions

- Basic watch function (hour and minute hands)
- Bluetooth link function with wena 3
 - Indicating the information of wena 3
 - Operating wena 3 with the watch buttons
 - Auto time-synchronization with wena 3

2. Frequency of crystal oscillator..... 32,768 Hz (Hz = Hertz ... Cycles per second)

3. Loss/gain (monthly rate)..... Less than 15 seconds (when the watch head is used without being linked with wena 3 and when the watch is worn on the wrist at normal temperature range between 5°C and 35°C)

4. Operational temperature range..... -5°C ~ +50°C

5. Driving system..... Step motor, 3 pieces

6. Battery..... Lithium battery, SB-T14 (CR2025), 1 piece

7. Battery life..... Approximately 2 years (in the case of communication connection with wena 3 for 24 hours a day, 10 button operations per day, and incoming call notification by the indicator hand 10 times a day)

8. IC (Integrated Circuit)..... Oscillator, frequency divider, driving and reception circuit: C-MOS-IC, 2 piece

※ The specifications above are subject to change without prior notice for product improvements.

Please note that the warranty and contact information are different for the clasp section (wena 3) of this watch. For repair and other concerns, refer to the warranty certificates and the instructions, and contact the respective service centers.

※ Before requesting to have your watch head repaired, be sure to remove the clasp section (wena 3).

→ How to remove the clasp section (wena 3) P.8

■ Watch head and band (not including wena 3)

Inquiries regarding use, repair, and maintenance of the watch head

**SEIKO CUSTOMER SERVICE CENTER
0120-181-671**

Reception hours: 9:30-17:30 (Monday through Friday)

For reception hours during the summer and New Year's holidays,
please visit our website

(<https://www.seikowatches.com/jp-ja/contact>)

※ If your phone is set to "number withheld," add "186" to the above phone number.

■ Clasp section (wena 3)

Repair inquiries for wena 3

Repair Service Center

Toll-free : **0120-252-645**

Mobile phone/PHS/some IP phones : **050-3754-9592**

Reception hours: 9:30-18:00 (Monday through Friday)

9:30-17:00 (Saturday, Sunday and public holiday)

※ For information other than repair, such as how to use wena 3, refer to the Startup Guide and the Reference Guide supplied with wena 3, and the wena support page.
(<http://wena.jp/support.html>)